



Karndean
Designflooring

Product Selector



At Karndean, we see flooring differently...

We travel the world in our quest to bring you exceptional floors that inspire and delight. From the ancient forests of Europe, to the remote Australian outback and beyond, we seek out expressive and intriguing forms in the natural world to influence our unique floor designs. By combining these original features with cutting edge design, we create simply beautiful floors that bring your vision to life.

Cover image: Washed Character Oak KPI44-7

We see flooring differently...

Creating simply beautiful floors that bring your vision to life

Travelling the world

Seeking expressive and intriguing forms

Developing unique floor designs



Contact us

For the information and help you need to design and specify Karndean Designflooring, please call us, visit our website or arrange a visit to your nearest showroom.

For samples, literature, sales support and technical information, call AUS: 1800 331 170, NZ: 0800 442 101.

Email: customerservice@karndean.com.au, customerservice@karndean.co.nz | Website: www.karndean.com

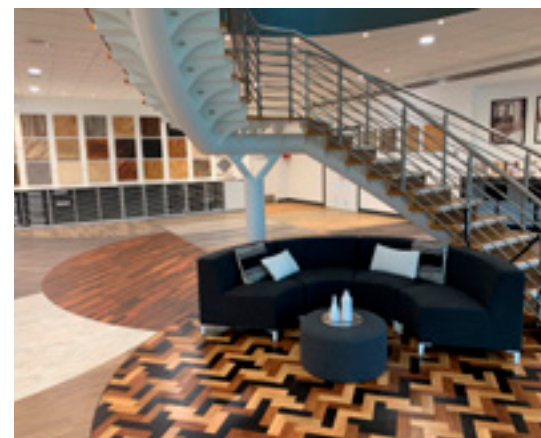

Contents

Our inspiration.....	4	Rigid core accessories	166
Contact us.....	6	Gluedown	163
Using this book	8	Designflooring explained.....	164
Sectors we work in.....	9	Image gallery.....	167
Environmental.....	10	Wood at a glance (gluedown only)	176
Digital tool suite.....	12	Stone at a glance (gluedown only).....	178
Our product formats	14	Laying patterns	180
Wood at a glance (all product formats & ranges)	18	Pattern guide	182
Stone at a glance (all product formats & ranges).....	22	Technical overview.....	184
Loose lay	25	Gluedown ranges wood	
Image gallery.....	26	- Art Select	186
Wood at a glance (loose lay only)	32	- Van Gogh	221
Stone at a glance (loose lay only).....	33	- Opus.....	226
Pattern guide	34	- Knight Tile	242
Technical overview.....	36	Gluedown ranges stone	
Loose lay ranges		- Opus.....	260
- Karndean LooseLay Longboard.....	38	- Knight Tile	272
- LooseLay Originals Wood.....	60	Kaleidoscope	280
- LooseLay Originals Stone	80	Design components	289
Rigid core	95	Design strips	290
Image gallery.....	96	Decorative borders.....	293
Wood at a glance (rigid core only).....	104	Resources	295
Pattern guide	104	Adhesives	296
Technical overview.....	106	Cleaning & maintenance	297
Rigid core ranges		Customer support.....	298
- Korlok wood	108	Continuing Professional	
- Korlok stone.....	130	Development (CPDs).....	299
- Van Gogh	144	Sample service.....	300
- Knight Tile wood	166	Warranty.....	301
- Knight Tile stone	184	Index	302

Using this book

We have created this Product Selector with your specification needs in mind. As the only company specialising in Luxury Vinyl Tile (LVT) and offering all major LVT categories, we truly have the perfect floor for any situation. Our vast collection of colours, designs and formats allows us to offer you the widest range of choice, while tools such as this Product Selector help you find the product that is just right for you.

In this book you will find our full loose lay, rigid core and gluedown offering: unique designs with carefully selected features such as bevelled edges, different emboss types, and effects such as liming and handscraping, all designed to enhance the natural beauty of the original woods and stones that inspired each product.

Use this guide to quickly find what you need:

Environmental, Karndean Designflooring and the environment - page 10

All ranges - at a glance, with both wood and stone - pages 18, 22

Image gallery, including case study images - pages 26, 96, and 167

Our product formats, see the benefits of Karndean Designflooring - page 14

Loose lay products, with its own 'at a glance' and technical overview - page 25

Rigid core products, with its own 'at a glance' and technical overview - page 104

Gluedown products, with its own 'at a glance' for wood and stone - page 163

Designflooring explained, add interest with our designflooring elements - page 164

Index, in both product name and product code order - page 302

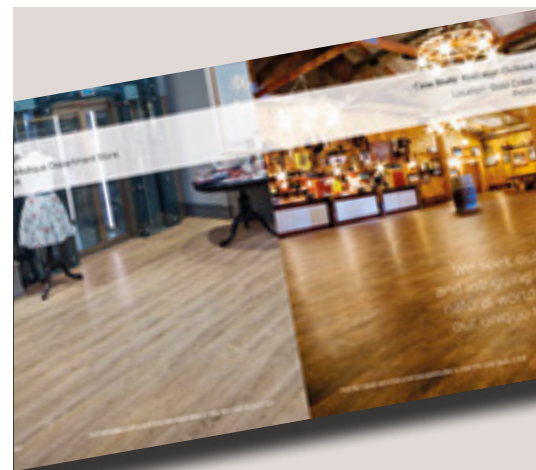

Sectors we work in

Retail

Whether a small town boutique or suburban superstore, eye-catching floor designs that guide consumers throughout the space are essential. Our unique design capabilities allow for the creation of zoning/wayfinding.



Healthcare

Cleanliness and durability are important in healthcare environments. With Karndean, you can have a durable, easy to maintain floor that creates a home-like atmosphere, contributing to a calm, healing environment.



Office

Offices are places for thought, discussion and creativity. Choosing Karndean Designflooring for the boardroom, reception or office is the key to creating a space that's comfortable, inspiring and practical.



Education

Karndean Designflooring's durable and low maintenance flooring helps you to create safe and inspiring educational environments for students of all ages.



Hospitality

In a sector where style, resilience and ease of keeping floors clean is vital, Karndean Designflooring is a proven choice for the demands of hotels, bars, restaurants, tourist attractions and leisure facilities.



Multi residential

Quality flooring adds value to new developments, and with Karndean Designflooring, property managers benefit from the more practical side of having a versatile, hardwearing and durable floor.



Environmental

Karndean Designflooring and the environment

At Karndean Designflooring we find inspiration for our products in the beauty of the natural world and feel passionate about bringing this into every product we create. In order to keep our environment protected we do everything we can to continuously improve our manufacturing processes to ensure sustainability whilst delivering best value. We have always aimed to make stylish and durable floors with the lowest possible impact on the environment, and have never had to compromise quality or performance in order to comply with legislation or meet environmental requirements.

Karndean Designflooring is a member of the Green Building Councils of Australia and New Zealand. All Karndean products and accessories are manufactured in facilities certified to the ISO 14001 Environmental Management and ISO 9001 Quality Management International Standards. Our approach is based on the use of recycled materials in our floor coverings and ensuring that the finished product is suitable for recycling if required.

What's more...

- All of our packaging is made using recycled material, which we continually review to ensure that it is environmentally friendly and fit for purpose
- We use individual logistical solutions to efficiently and effectively transport our products
- Our storage facilities use high density racking to maximise capacity and minimise impact
- Our offices are introducing innovative energy saving techniques
- We are members of the Green Building Council Australia (GBCA) and Green Building Council New Zealand (NZGBC)
- All of our adhesives are water based, solvent-free and have low VOC emissions

The future

Our continued product innovation focuses on reducing our environmental impact and complying with environmental legislation and recognized certifications worldwide. Our aim is to remain the leading supplier of LVT flooring and to have a market-leading environmental record of achievement through the development of sustainable products and processes.

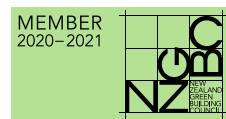

Digital tool suite

To ensure you have everything you need from Karndean Designflooring for your projects, visit karndean.com:

Technical datasheets • Downloads • News & blogs • CAD files

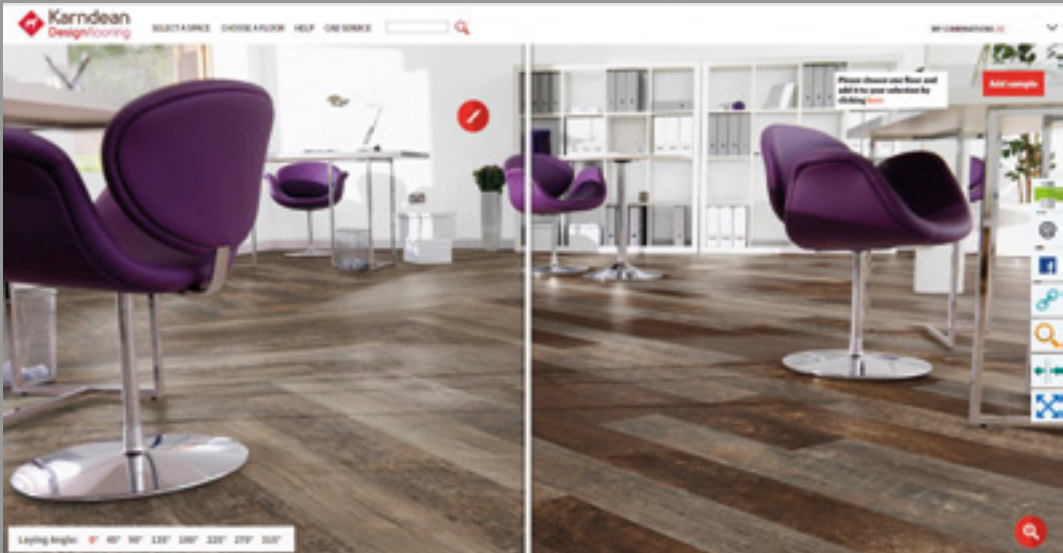

Digital specification library

Our interactive digital specification library lets you view our wide range of floors in typical commercial settings and download them as CAD files.

With improved usability, a range of different sector specific settings, optional colour schemes and side-by-side comparison, you can discover our stylish and highly practical flooring in a truly visual manner.

www.karndean.com/digitalspecificationlibrary



Product Selector online

Available at www.karndean.com/productselector, the Product Selector page turner is an online version of this book which is regularly updated as new Karndean products are launched.

For phone, tablet and desktop, there are two ways to use the online Product Selector:

- **Browse online** – bookmark the link above to readily access the online page turner from any device with a web connection.
- **Download** – from the online page turner, you have the option to download a PDF version of the book to your local device, meaning you can always have it available as a reference even without a connection to the internet.

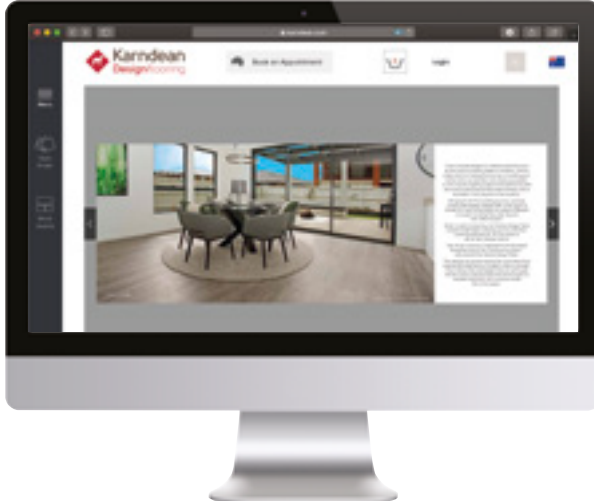
www.karndean.com/productselector



Case studies

Our continually expanding library of inspiring case studies gives you a glimpse into how our products are used in commercial applications, large and small.

Visit the case studies section of our commercial website to view real world Karndean Designflooring installations across a variety of sectors.

www.karndean.com/commercialcasestudies

Moodboards

While browsing the Karndean website, click on and save products you like and create different moodboards to reflect different styles and projects.

With this tool, you can build a collection of different ideas by sector or project theme, which can be easily accessed and shared anytime with clients.

www.karndean.com/commercialmoodboards



Kaleidoscope Floorstyle

Similar to the digital specification library, our sophisticated online Kaleidoscope Floorstyle tool helps specifiers to visualise a bespoke floor design in a commercial setting.

A user-friendly interactive specification program, Floorstyle features all six geometric Kaleidoscope designs - Apex, Cubix, Pyramid, Tripoint, Pennon and Hexa - with over 100 colourways to choose from.

www.karndean.com/kaleidoscopefloorstyle



Video hub

From product features to design and installation hints and tips, the video hub captures our full collection of video content all in one place.

www.karndean.com/commercialvideohub

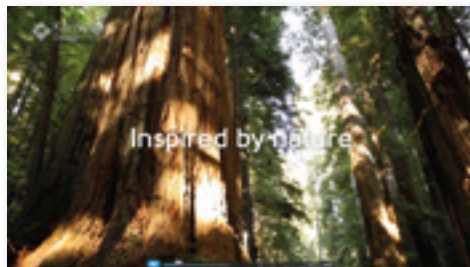
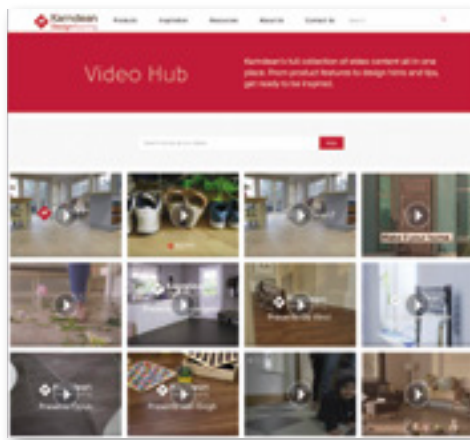

Our product formats

We offer three types of products: loose lay, rigid core and gluedown.

We are proud to say all our products offer essential benefits that make Karndean Designflooring the ideal choice for all flooring spaces, from large commercial specifications to small residential rooms. On the following pages, you will see the individual benefits of our three distinct product formats: loose lay, rigid core and gluedown. The following benefits apply to all Karndean Designfloors:



Realistic wood and stone designs

Inspired by nature, our products are designed in-house and realistically replicate the look and feel of real wood and stone materials.



Waterproof

Unlike laminate and engineered hardwoods, our floors are impervious to water and will not swell, crack or warp when wet, making them perfect for restaurants, hotels and other areas prone to spills and heavy foot traffic.



Hygienic

Unlike carpets, our floors don't hold dust, dirt, pollen or other allergens. Our cleaning products also kill 99.9% of environmental germs.



100% recyclable

We do everything we can to meet and exceed legislation and environmental guidelines in every region we sell our products, meaning you can count on the fact you're choosing a safe and environmentally-friendly floor.



Comfortable underfoot

Our products are much warmer and quieter underfoot, giving you the look of real wood and stone but without the drawbacks of cold tiles or clicking shoes.



Durable

Unlike other flooring alternatives, Karndean Designflooring gives you the look and feel of natural products but with the durability and resilience of luxury vinyl.



Acoustic qualities

All Karndean Designflooring products aid in the reduction of noise transfer and are tested for acoustic impact sound reduction. Please see technical data sheets for supporting documentation.



K-Guard+

Each of our floors is finished with K-Guard+, adding extra protection against scuffs and scratches, and making it even easier to clean and look after.



Low maintenance

A regular sweep and mop with Karndean Clean is all you need to keep your Karndean floor looking great. With Karndean, you also don't have to worry about any sanding, refinishing, staining or varnishing.



Product warranties

All Karndean floors are covered by a commercial warranty (10-20 years) and a lifetime residential warranty, giving you and your clients peace of mind.



Resists indentation

Our products will retain their shape under the weight of heavy objects and fixtures.

Loose lay

Karndean LooseLay Originals features our K-Wave friction grip backing which helps hold the product to the subfloor without adhesive, making it quick and easy to install. Ideal for underfloor access panels and temporary roomsets, each plank can be lifted individually where required.

LooseLay Originals (wood) | 1050 x 250mm

LooseLay Originals (stone) | 500 x 610mm

LooseLay Longboard | 1500 x 250mm

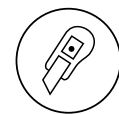
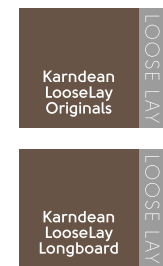

Easy access to underfloor panels



Reduces noise transfer to room below by 14dB

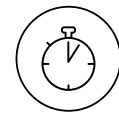

Quick and easy to install

Rigid core

Our Korlok and Van Gogh rigid core ranges are ideal for installations where acoustics, uneven subfloors or preservation of existing hard floors need to be considered. 5G® click-locking mechanisms allows for quick installation and the pre-attached acoustic backing means no separate underlay is needed.

Korlok (wood) | 1420 x 225mm

Korlok (stone) | 457 x 600mm

Van Gogh | 1220 x 180mm

Knight Tile (wood) | 1220 x 180mm

Knight Tile (stone) | 457 x 305mm

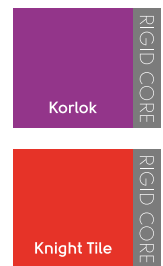

Hides subfloor imperfections



Reduces noise transfer to room below by 19dB



Enables preservation of existing floor

Gluedown

Our gluedown ranges offer our widest choice of colours and sizes. Features such as textured emboss or our premium handscraped finish, wide bevels or flat edges make each range unique to Karndean Designflooring and highlight the faithful replication of the original wood and stone that inspired each of our products.

Wide selection of sizes: from the **229 x 76mm** planks of Art Select parquet to the extra large **1219 x 229mm** planks in the Opus range. Plus, tiles ranging from **305 x 457mm** in Knight Tile to Opus's large **457 x 610mm**.

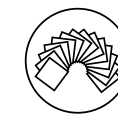
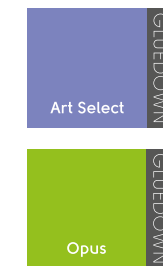

Available in a wide range of designs, colours, textures and sizes

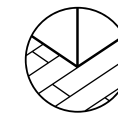

No expansion gap required

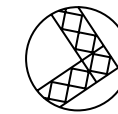

Can be personalised with design strips or corresponding borders

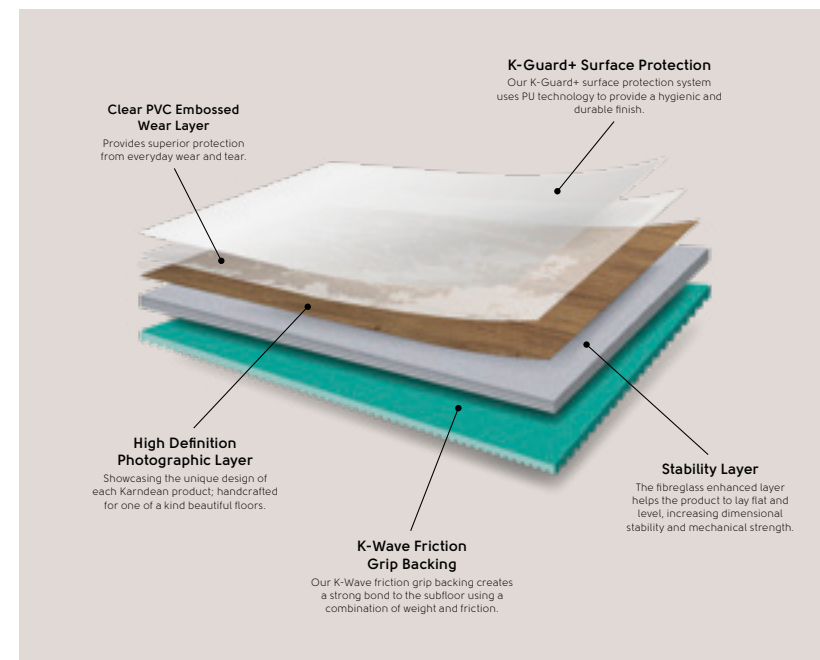

Wood at a glance (all product formats & ranges)

Gluedown: ■ Art Select | ■ Van Gogh | ■ Opus | ■ Knight Tile | ■ Karndean LooseLay

Rigid core: ■ Korlok | ■ Van Gogh | ■ Knight Tile

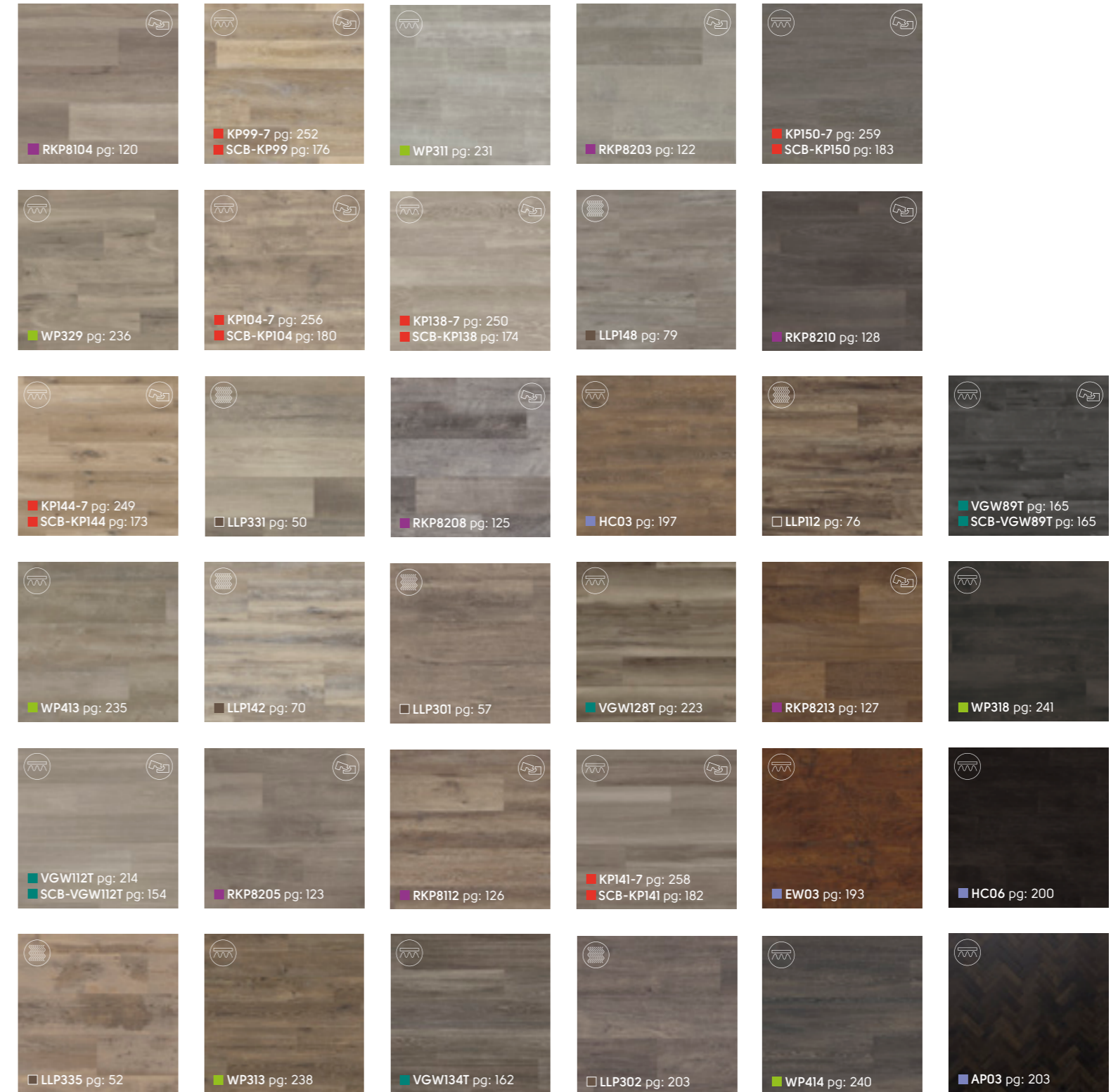

Wood at a glance (all product formats & ranges continued...)

Gluedown: ■ Art Select | ■ Van Gogh | ■ Opus | ■ Knight Tile | ■ Karndean LooseLay

Rigid core: ■ Korlok | ■ Van Gogh | ■ Knight Tile

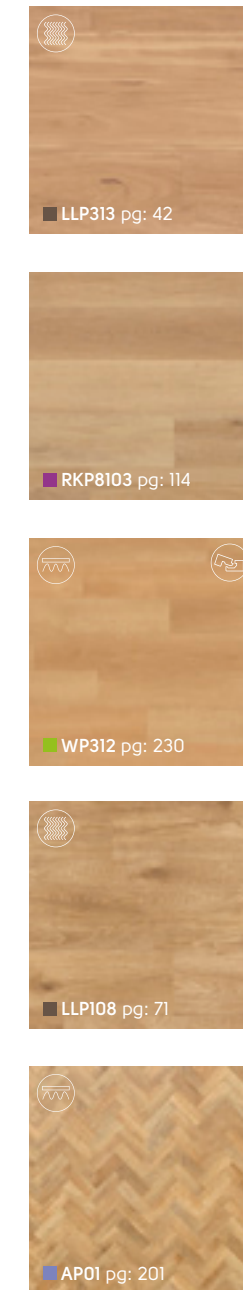
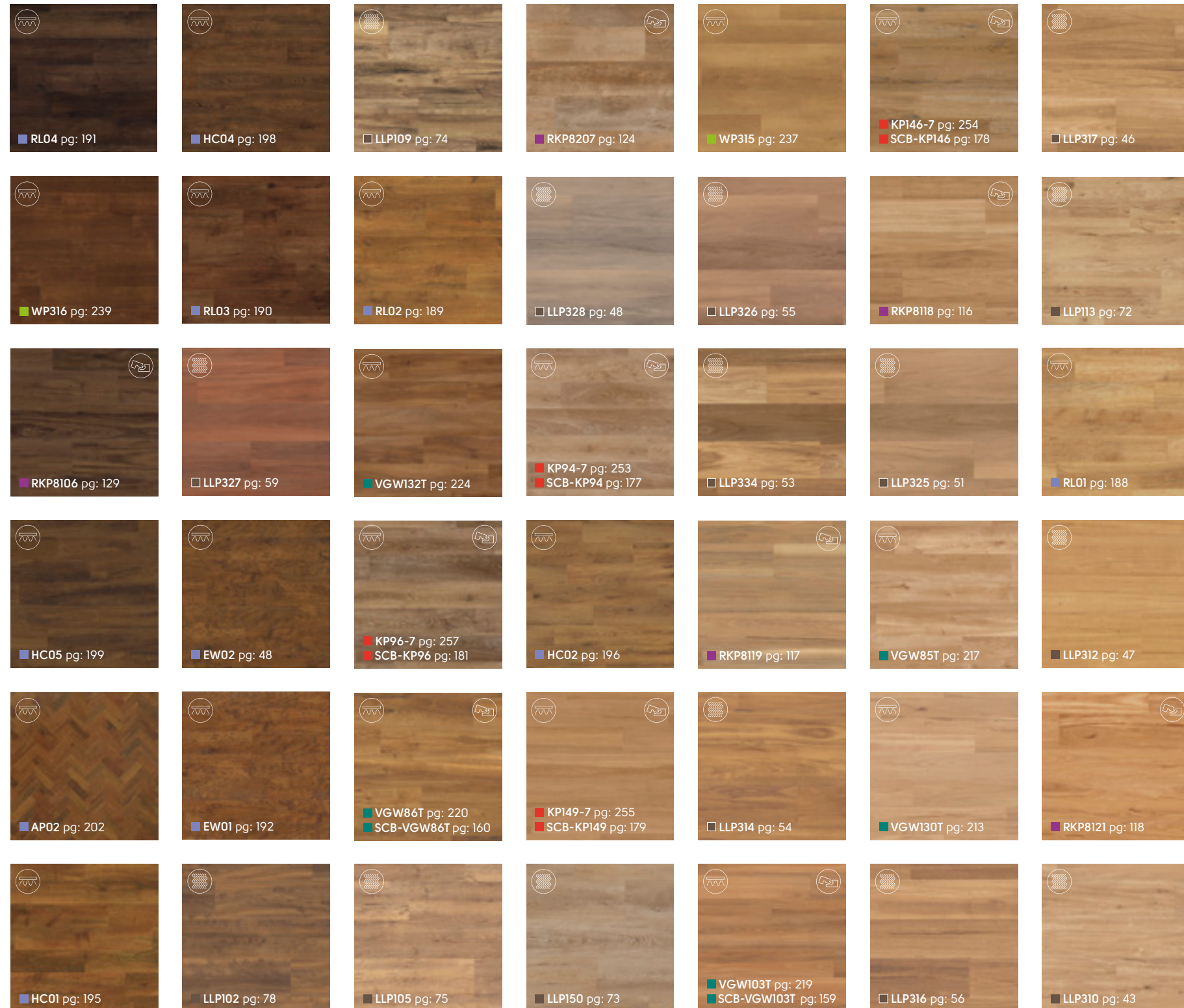

Stone at a glance (all product formats & ranges)

■ Opus | ■ Knight Tile | ■ Karndean LooseLay | ■ Korlok



□ Dakota LLT212



Loose lay





At Karndean, we see flooring differently.

□ Ochre Ironbark LLP326



■ Bridgeport LLP157



Case Study: Henley Homes

Location: Clyde North, Victoria
Product: Karndean LooseLay Longboard



□ Twilight Oak LLP301

Visit [Karndean.com/commercialcasestudies](https://www.karndean.com/commercialcasestudies) to view this case study in full



Case Study: Welly Road Childcare

Location: Mount Barker, South Australia
Product: Korlok

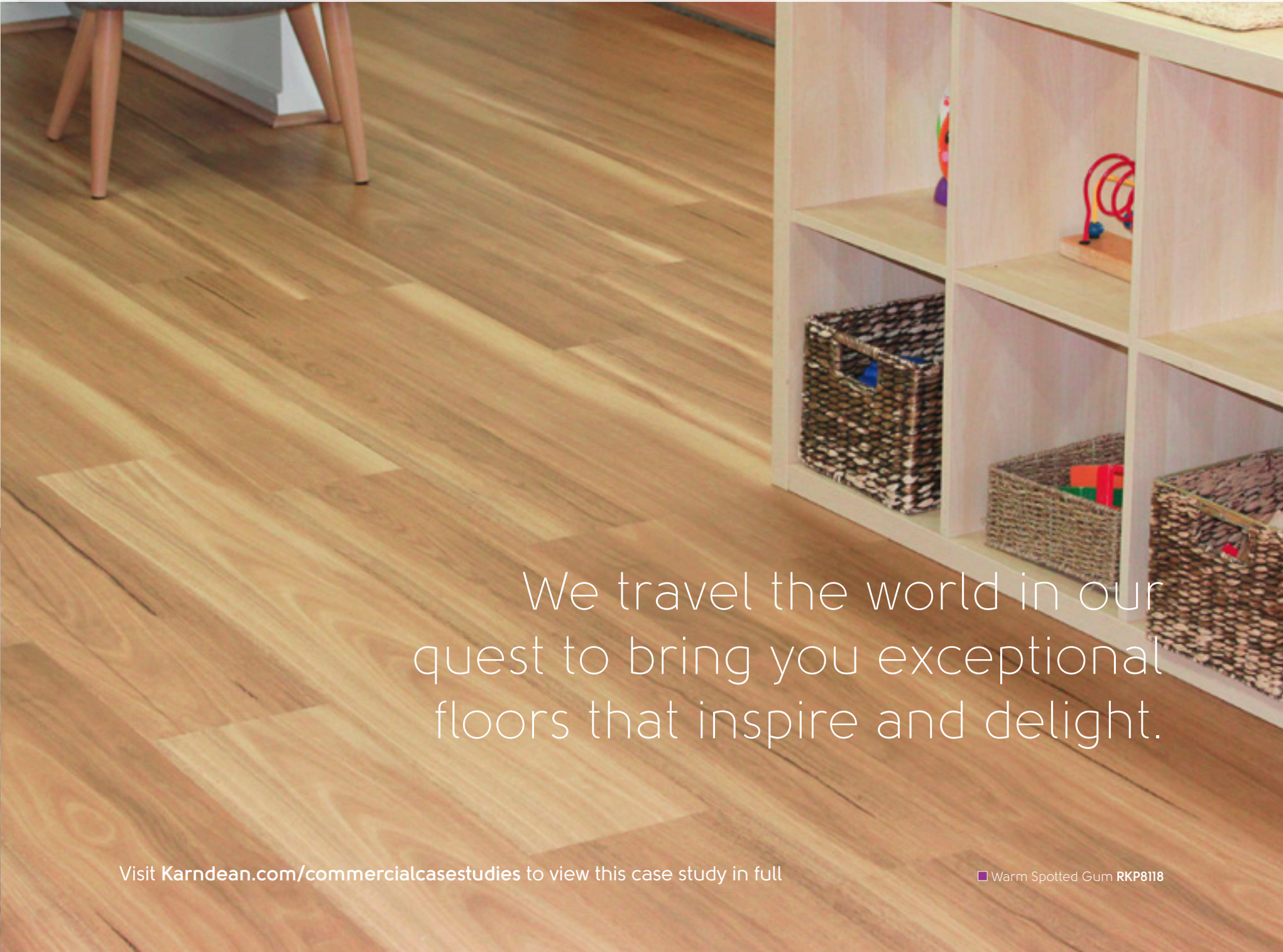

We travel the world in our quest to bring you exceptional floors that inspire and delight.

Visit [Karndean.com/commercialcasestudies](https://www.karndean.com/commercialcasestudies) to view this case study in full

■ Warm Spotted Gum RKP8118



From the ancient forests
of Europe, to the remote
Australian outback.



Wood at a glance (loose lay only)

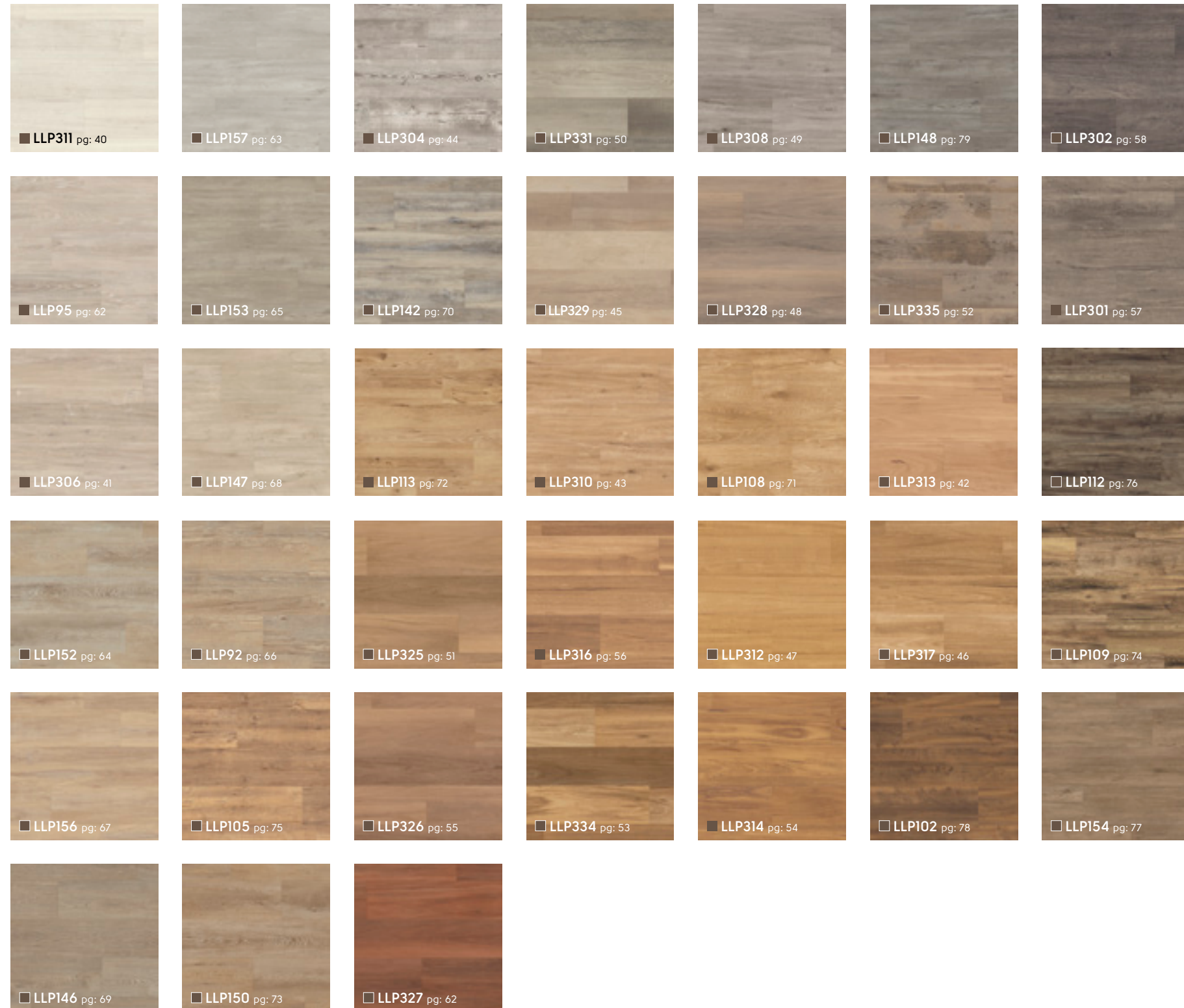

Stone at a glance (loose lay only)

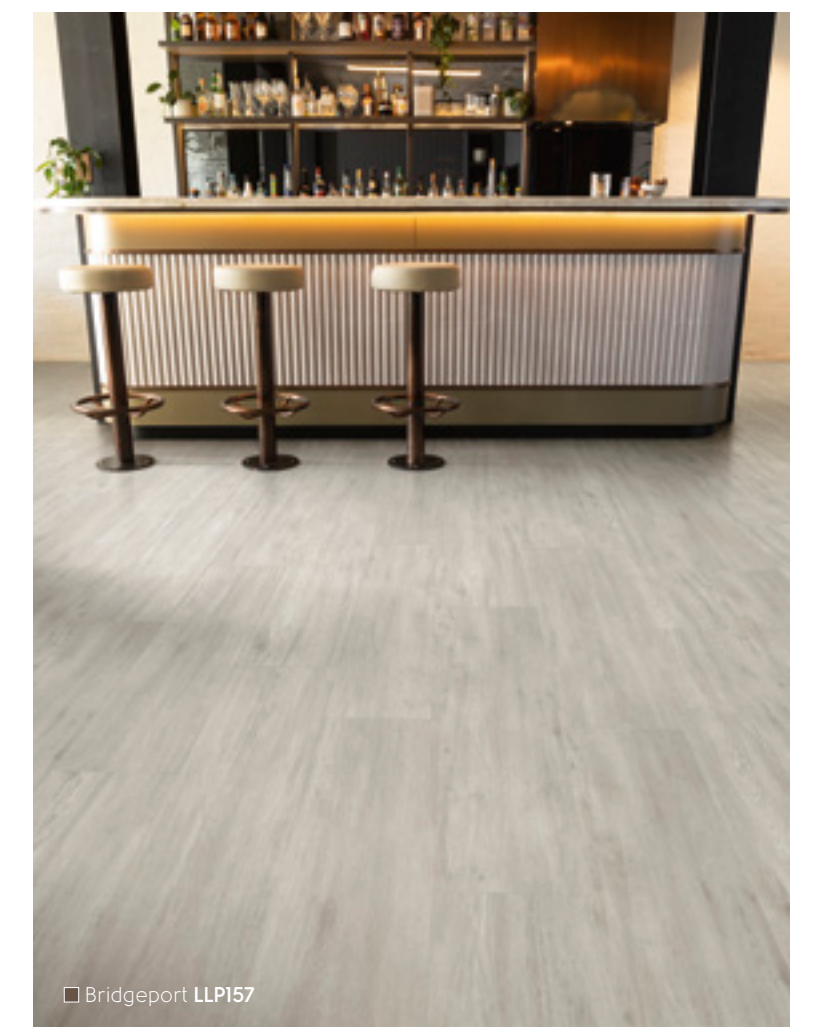
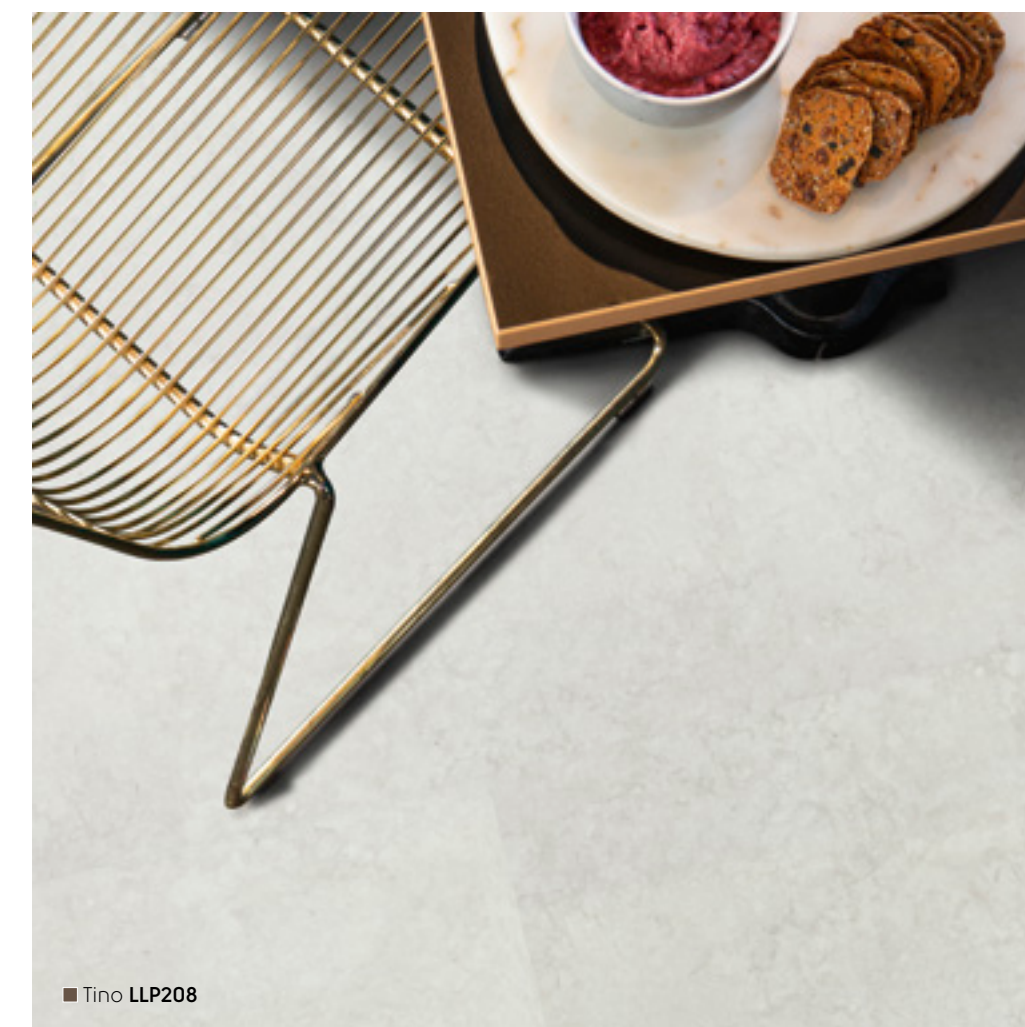
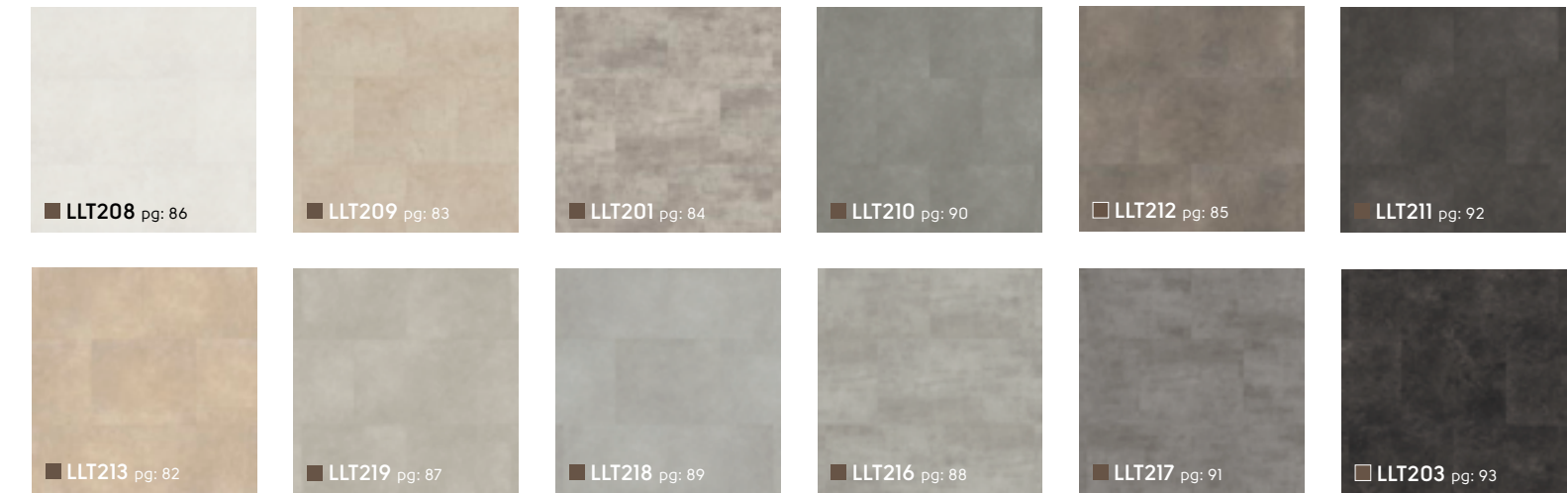

Pattern guide

Create an eye-catching design with Karndean LooseLay. Our planks and tiles are multi-directional, allowing you to create a layout that adds visual interest to any space.



Wood layouts



Herringbone

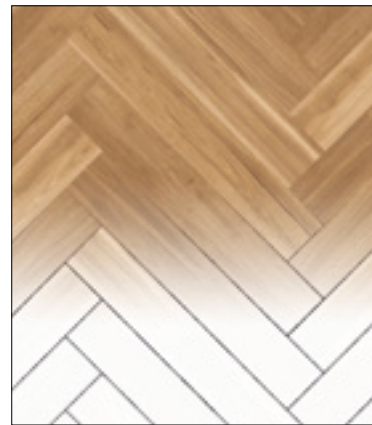

Staggered straight

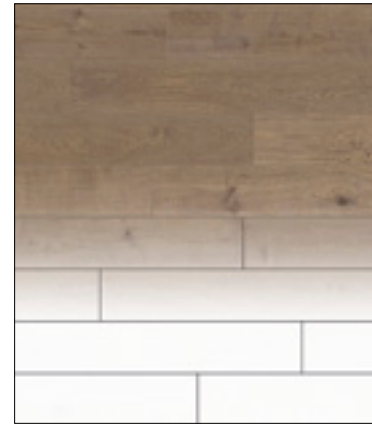

45° with border



Striped diagonal



Bring your pattern ideas to life using our Digital Specification Library (www.karndean.com/digitalspecificationlibrary) or contact your commercial business manager for more information on incorporating these designs into a future project.

Stone layouts



Brick lay



45° diagonal

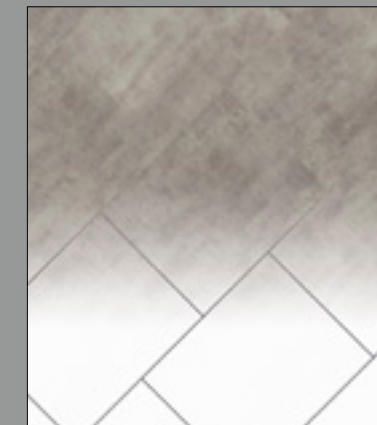

Herringbone



Striped

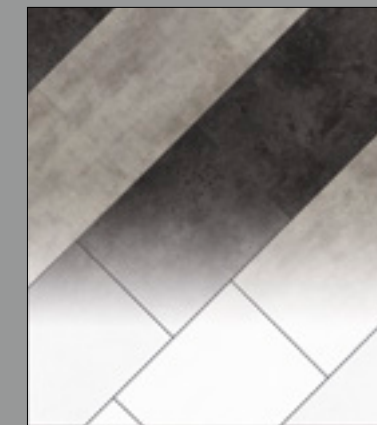

Mixed wood & stone layouts





















Striped diagonal



Note: Do not cut Karndean LooseLay planks or tiles into pieces that are smaller than the width of the product, as this will affect the quality of the installation.



Technical overview (loose lay only)

	Standard	Karndean LooseLay Longboard (see page: 38)	Karndean LooseLay Originals (see page: 60 and 80)
 Size	EN ISO 24342	1500 mm x 250 mm (59.05" x 9.84")	1050 mm x 250 mm (41.3" x 9.85") 500 mm x 610 mm (19.7" x 24")
 Thickness	EN ISO 24346	4.5 mm	4.5 mm
 Wear layer		0.5 mm	0.5 mm
Surface treatment		K-Guard+ PU coating	K-Guard+ PU coating
Backing		PVC Friction Pad	PVC Friction Pad
Warranty	Commercial Residential	15 years wear* Lifetime wear*	15 years wear* Lifetime wear*
 Bevelled edge		No	No
 Standards	ASTM F1700	Pass	Pass
 Classification		33: Commercial heavy 23: Domestic heavy	33: Commercial heavy 23: Domestic heavy
 Reaction to fire	AS/NZS ISO 9239.1:2003	CRF: 8.3 kW/m ² Smoke value: 143% min	CRF: 8.3 kW/m ² Smoke value: 143% min
 Staining resistance	EN ISO 26987/EN 423 ASTM F925	Excellent Pass	Excellent Pass
 Colour fastness to light	ISO 105-B02 ASTM F1515	Pass (≥7) Pass (<8)	Pass (≥7) Pass (<8)
 Abrasion resistance	EN 660-2 ISO 10582 ASTM D3884	Group T Type 1 Pass	Group T Type 1 Pass
 Flexibility	ISO 24344	Pass	Pass
 Dimensional stability	EN 434/ISO 23999 ASTM F2199	Pass (≤0.10%) Pass	Pass (≤0.10%) Pass
NCC 2016 F5.3 (a) result refer to Karndean INSUL Marshall Day Software report for your MULTI Res specification including AAAC Star rating			
 Acoustic impact noise reduction	ISO 140-8 Improved Impact Sound Insulation	ΔL _w = 14 dB	ΔL _w = 14 dB
	ASTM E492-09 Impact Insulation Class	IIC 56 dB	IIC 56 dB
Suitable for use on upper floors of residential high-rise apartment buildings without the need for a separate acoustic underlay under certain build specifications – precise details available from Karndean.			
 Electrical behaviour body voltage	EN 1815 AATCC 134-1996	Pass Pass	Pass Pass
 Indentation - residual	EN 433 / ISO 24343-1 ASTM F1914	Pass (≤0.1 mm) Pass (<8%)	Pass (≤0.1 mm) Pass (<8%)
 Castor chair continuous use	EN 425 / ISO 4918	Pass	Pass
 Thermal resistance	ISO 8302	0.0245 m ² K/W Suitable for underfloor heating. Max 27°C	0.0245 m ² K/W Suitable for underfloor heating. Max 27°C
 Slip resistance**	AS/NZS 4586:2013	R10	See individual product pages
 Adhesive	Karndean Hi-Tack PS Adhesive when applicable. Please refer to Installation Guidelines.		
 Recycling		Suitable	Suitable
Environmental	Floorscore SCS- EC10.3-2014 v4.0	GBCA/NZGBC GreenStar Rating System	GreenTag Level 'A'; LCA Silver Plus; Best Practice PVC
		Floorscore SCS-EC10.3-2014 v4.0	Indoor air quality certified; Compliant low emitting VOC emissions.
		Indoor Air Comfort	Gold certification Compliant low emitting VOC emissions.
		Environmental Product Declaration	Product-specific Type III EPD (products with external third-party verification)
		NSF/ANSI 332	Sustainability Assessment for Resilient Floor Coverings; Silver certified product
 Phthalate free		Yes	Yes

* Subject to terms. Please see our website.

** Slip resistance is measured on ex-factory product. Slip resistance can be affected by surface contamination, use and how the product is maintained.



Karndean LooseLay Longboard



1500mm x 250mm (59.1" x 9.85")



Bleached Tasmanian Oak **LLP311**



Pearl Oak **LLP306**



North Coast Blackbutt **LLP313**



Champagne Oak **LLP310**



Weathered Heart Pine **LLP304**



Pure Fabric Oak **LLP329**



Lemon Spotted Gum **LLP317**



Tasmanian Oak **LLP312**

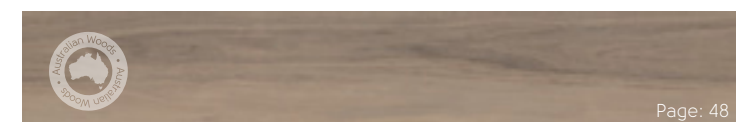

Blended Ironbark **LLP328**



French Grey Oak **LLP308**

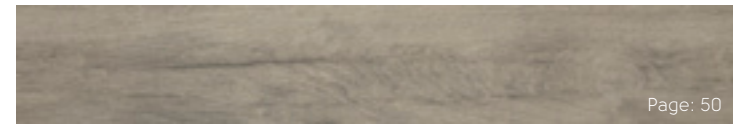

Shadow Fabric Oak **LLP331**



Honey Ironbark **LLP325**

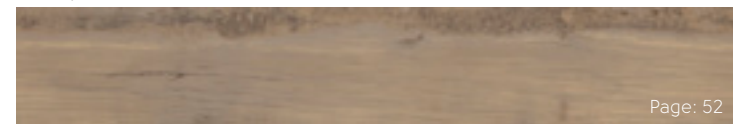

Weathered Amercian Pine **LLP335**

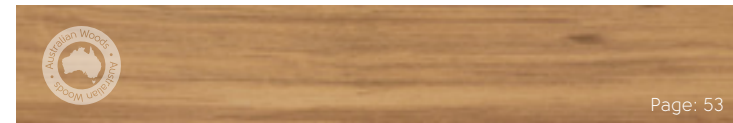

Australian Wormy Chestnut **LLP334**



Embered Blackbutt **LLP314**



Ochre Ironbark **LLP326**



Mountain Spotted Gum **LLP316**



Twilight Oak **LLP301**

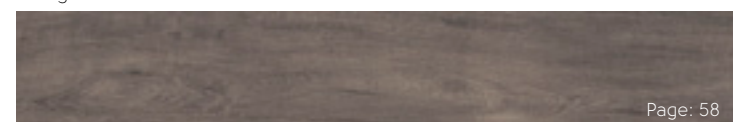

Raven Oak **LLP302**



Natural Ironbark **LLP327**

Karndean LooseLay Longboard



A preferred alternative to carpet tiles and other floating floors, Karndean's innovative LooseLay products give you the intricate design and durability you expect from a Karndean product, but in a unique format that can be installed quickly and easily in nearly any space. Featuring enhanced acoustic properties, ISO 140-8 and excellent environmental credentials, LooseLay Longboard is the perfect choice for a variety of installations. Its planks are 42% longer than standard LooseLay, facilitating even faster installation times. LooseLay Longboard can be laid over most existing hard floors and doesn't require glue in most installations. What's more, it can be installed on subfloors with an RH of up to 95%.



	Standard	Result
Size	EN ISO 24342	1500 mm x 250 mm
Thickness	EN ISO 24346	4.5 mm
Wear layer		0.5 mm
Surface treatment		K-Guard+ PU coating
Backing		PVC Friction Pad
Warranty	Commercial Residential	15 years wear* Lifetime wear*
Bevelled edge		No
Standards	ASTM F1700	Pass
Classification		33: Commercial heavy 23: Domestic heavy
Reaction to fire	AS/NZS ISO 9239.1:2003	CRF: 8.3 kW/m ² Smoke value: 143% min
Staining resistance	EN ISO 26987/EN 423 ASTM F925	Excellent Pass
Colour fastness to light	ISO 105-B02 ASTM F1515	Pass (≥7) Pass (<8)
Abrasion resistance	EN 649 ISO 10582 ASTM D3884	Group T Type 1 Pass
Flexibility	ISO 24344	Pass
Dimensional stability	EN 434/ISO 23999 ASTM F2199	Pass (<0.10%) Pass
Acoustic impact noise reduction	NCC 2016 F5.3 (a) result refer to Karndean INSUL Marshall Day Software report for your MULTI Res specification including AAAC Star rating ISO 140-8 Improved Impact Sound Insulation ASTM E492-09 Impact Insulation Class	$\Delta L_w = 14$ dB IIC 56 dB
	Suitable for use on upper floors of residential high-rise apartment buildings without the need for a separate acoustic underlay under certain build specifications – precise details available from Karndean.	
Electrical behaviour body voltage	EN 1815 AATCC 134-1996	Pass Pass
Indentation - residual	EN 433 / ISO 24343-1 ASTM F1914	Pass (<0.1 mm) Pass (<8%)
Castor chair continuous use	EN 425 / ISO 4918	Pass
Thermal resistance	ISO 8302	0.0245 m ² K/W Suitable for underfloor heating. Max 27°C
Slip resistance**	AS/NZS 4586:2013	R10
Adhesive	Karndean Hi-Tack PS Adhesive when applicable. Please refer to Installation Guidelines.	
Recycling	Suitable	
	GBCA/NZGBC GreenStar Rating System	GreenTag Level 'A'; LCA Silver Plus; Best Practice PVC
	Floorscore SCS- EC10.3-2014 v4.0	Indoor air quality certified; Compliant low emitting VOC emissions.
Environmental	Indoor Air Comfort	Gold certification Compliant low emitting VOC emissions.
	Environmental Product Declaration	Product-specific Type III EPD (products with external third-party verification)
	NSF/ANSI 332	Sustainability Assessment for Resilient Floor Coverings; Silver certified product
Phthalate free	Yes	

* Subject to terms. Please see our website.

** Slip resistance is measured on ex-factory product. Slip resistance can be affected by surface contamination, use and how the product is maintained.

Bleached Tasmanian Oak **LLP311**



Pearl Oak **LLP306**



Size	1500mm x 250mm (59.1" x 9.85")
Thickness	4.5mm
Wear Layer	0.5mm
Bevel	No
Box Quantity	8 Planks/3m ²

Suitability/Application:
Commercial heavy duty use
Domestic extra heavy duty use

Slip Resistance/Result:
Oil Wet Ramp R10

Technical Specifications:
Page: 39

Size	1500mm x 250mm (59.1" x 9.85")
Thickness	4.5mm
Wear Layer	0.5mm
Bevel	No
Box Quantity	8 Planks/3m ²

Suitability/Application:
Commercial heavy duty use
Domestic extra heavy duty use

Slip Resistance/Result:
Oil Wet Ramp R10

Technical Specifications:
Page: 39

North Coast Blackbutt LLP313



Champagne Oak LLP310



Size	1500mm x 250mm (59.1" x 9.85")
Thickness	4.5mm
Wear Layer	0.5mm
Bevel	No
Box Quantity	8 Planks/3m ²

Suitability/Application:
Commercial heavy duty use
Domestic extra heavy duty use

Slip Resistance/Result:
Oil Wet Ramp R10

Technical Specifications:
Page: 39

Size	1500mm x 250mm (59.1" x 9.85")
Thickness	4.5mm
Wear Layer	0.5mm
Bevel	No
Box Quantity	8 Planks/3m ²

Suitability/Application:
Commercial heavy duty use
Domestic extra heavy duty use

Slip Resistance/Result:
Oil Wet Ramp R10

Technical Specifications:
Page: 39

Weathered Heart Pine **LLP304**



Pure Fabric Oak **LLP329**



Size	1500mm x 250mm (59.1" x 9.85")
Thickness	4.5mm
Wear Layer	0.5mm
Bevel	No
Box Quantity	8 Planks/3m ²

Suitability/Application:
Commercial heavy duty use
Domestic extra heavy duty use

Slip Resistance/Result:
Oil Wet Ramp R10

Technical Specifications:
Page: 39

Size	1500mm x 250mm (59.1" x 9.85")
Thickness	4.5mm
Wear Layer	0.5mm
Bevel	No
Box Quantity	8 Planks/3m ²

Suitability/Application:
Commercial heavy duty use
Domestic extra heavy duty use

Slip Resistance/Result:
Oil Wet Ramp R10

Technical Specifications:
Page: 39

Lemon Spotted Gum LLP317



Tasmanian Oak LLP312



Size	1500mm x 250mm (59.1" x 9.85")
Thickness	4.5mm
Wear Layer	0.5mm
Bevel	No
Box Quantity	8 Planks/3m ²

Suitability/Application:
Commercial heavy duty use
Domestic extra heavy duty use

Slip Resistance/Result:
Oil Wet Ramp R10

Technical Specifications:
Page: 39

Size	1500mm x 250mm (59.1" x 9.85")
Thickness	4.5mm
Wear Layer	0.5mm
Bevel	No
Box Quantity	8 Planks/3m ²

Suitability/Application:
Commercial heavy duty use
Domestic extra heavy duty use

Slip Resistance/Result:
Oil Wet Ramp R10

Technical Specifications:
Page: 39

Blended Ironbark LLP328



French Grey Oak LLP308



Size	1500mm x 250mm (59.1" x 9.85")
Thickness	4.5mm
Wear Layer	0.5mm
Bevel	No
Box Quantity	8 Planks/3m ²

Suitability/Application:
Commercial heavy duty use
Domestic extra heavy duty use

Slip Resistance/Result:
Oil Wet Ramp R10

Technical Specifications:
Page: 39

Size	1500mm x 250mm (59.1" x 9.85")
Thickness	4.5mm
Wear Layer	0.5mm
Bevel	No
Box Quantity	8 Planks/3m ²

Suitability/Application:
Commercial heavy duty use
Domestic extra heavy duty use

Slip Resistance/Result:
Oil Wet Ramp R10

Technical Specifications:
Page: 39

Shadow Fabric Oak LLP331



Size	1500mm x 250mm (59.1" x 9.85")
Thickness	4.5mm
Wear Layer	0.5mm
Bevel	No
Box Quantity	8 Planks/3m ²

Suitability/Application:
Commercial heavy duty use
Domestic extra heavy duty use

Slip Resistance/Result:
Oil Wet Ramp R10

Technical Specifications:
Page: 39

Honey Ironbark LLP325



Size	1500mm x 250mm (59.1" x 9.85")
Thickness	4.5mm
Wear Layer	0.5mm
Bevel	No
Box Quantity	8 Planks/3m ²

Suitability/Application:
Commercial heavy duty use
Domestic extra heavy duty use

Slip Resistance/Result:
Oil Wet Ramp R10

Technical Specifications:
Page: 39

Weathered American Pine LLP335



Australian Wormy Chestnut LLP334



Size	1500mm x 250mm (59.1" x 9.85")
Thickness	4.5mm
Wear Layer	0.5mm
Bevel	No
Box Quantity	8 Planks/3m ²

Suitability/Application:
Commercial heavy duty use
Domestic extra heavy duty use

Slip Resistance/Result:
Oil Wet Ramp R10

Technical Specifications:
Page: 39

Size	1500mm x 250mm (59.1" x 9.85")
Thickness	4.5mm
Wear Layer	0.5mm
Bevel	No
Box Quantity	8 Planks/3m ²

Suitability/Application:
Commercial heavy duty use
Domestic extra heavy duty use

Slip Resistance/Result:
Oil Wet Ramp R10

Technical Specifications:
Page: 39

Embered Blackbutt LLP314



Size	1500mm x 250mm (59.1" x 9.85")
Thickness	4.5mm
Wear Layer	0.5mm
Bevel	No
Box Quantity	8 Planks/3m ²

Suitability/Application:
Commercial heavy duty use
Domestic extra heavy duty use

Slip Resistance/Result:
Oil Wet Ramp R10

Technical Specifications:
Page: 39

Ochre Ironbark LLP326



Size	1500mm x 250mm (59.1" x 9.85")
Thickness	4.5mm
Wear Layer	0.5mm
Bevel	No
Box Quantity	8 Planks/3m ²

Suitability/Application:
Commercial heavy duty use
Domestic extra heavy duty use

Slip Resistance/Result:
Oil Wet Ramp R10

Technical Specifications:
Page: 39

Mountain Spotted Gum LLP316



Twilight Oak LLP301



Size	1500mm x 250mm (59.1" x 9.85")
Thickness	4.5mm
Wear Layer	0.5mm
Bevel	No
Box Quantity	8 Planks/3m ²

Suitability/Application:
Commercial heavy duty use
Domestic extra heavy duty use

Slip Resistance/Result:
Oil Wet Ramp R10

Technical Specifications:
Page: 39

Size	1500mm x 250mm (59.1" x 9.85")
Thickness	4.5mm
Wear Layer	0.5mm
Bevel	No
Box Quantity	8 Planks/3m ²

Suitability/Application:
Commercial heavy duty use
Domestic extra heavy duty use

Slip Resistance/Result:
Oil Wet Ramp R10

Technical Specifications:
Page: 39

Raven Oak LLP302



Natural Ironbark LLP327



Size	1500mm x 250mm (59.1" x 9.85")
Thickness	4.5mm
Wear Layer	0.5mm
Bevel	No
Box Quantity	8 Planks/3m ²

Suitability/Application:
Commercial heavy duty use
Domestic extra heavy duty use

Slip Resistance/Result:
Oil Wet Ramp R10

Technical Specifications:
Page: 39

Size	1500mm x 250mm (59.1" x 9.85")
Thickness	4.5mm
Wear Layer	0.5mm
Bevel	No
Box Quantity	8 Planks/3m ²

Suitability/Application:
Commercial heavy duty use
Domestic extra heavy duty use

Slip Resistance/Result:
Oil Wet Ramp R10

Technical Specifications:
Page: 39

LooseLay Originals Wood

1050mm x 250mm (41.3" x 9.85")



LooseLay Originals Wood



Karndean LooseLay is an innovative format of luxury vinyl flooring featuring a friction grip backing that holds the product in place without the need for clicking or locking. It's easy to install, boasts enhanced acoustic properties and is 100% recyclable. In some spaces we do recommend the use of a tackifier. Please see our website for details. The collection includes 24 wood look planks available in a wide range of designs and tones. From the light rustic tones of Country Oak through to the rich brown tones of Dover, our LooseLay wood collection offers something to suit any space.



	Standard	Result
Size	EN ISO 24342	1050 mm x 250 mm
Thickness	EN ISO 24346	4.5 mm
Wear layer		0.5 mm
Surface treatment		K-Guard+ PU coating
Backing		PVC Friction Pad
Warranty	Commercial Residential	15 years wear* Lifetime wear*
Bevelled edge		No
Standards	ASTM F1700	Pass
Classification		33: Commercial heavy 23: Domestic heavy
Reaction to fire	AS/NZS ISO 9239.1:2003	CRF: 8.3 kW/m ² Smoke value: 143% min
Staining resistance	EN ISO 26987/EN 423 ASTM F925	Excellent Pass
Colour fastness to light	ISO 105-B02 ASTM F1515	Pass (≥7) Pass (<8)
Abrasion resistance	EN 649 ISO 10582 ASTM D3884	Group T Type 1 Pass
Flexibility	ISO 24344	Pass
Dimensional stability	EN 434/ISO 23999 ASTM F2199	Pass (≤0.10%) Pass
Acoustic impact noise reduction	NCC 2016 F5.3 (a) result refer to Karndean INSUL Marshall Day Software report for your MULTI Res specification including AAAC Star rating ISO 140-8 Improved Impact Sound Insulation	ΔL _w = 14 dB
	ASTM E492-09 Impact Insulation Class	IIC 56 dB
	Suitable for use on upper floors of residential high-rise apartment buildings without the need for a separate acoustic underlay under certain build specifications – precise details available from Karndean.	
Electrical behaviour body voltage	EN 1815 AATCC 134-1996	Pass Pass
Indentation - residual	EN 433 / ISO 24343-1 ASTM F1914	Pass (≤0.1 mm) Pass (<8%)
Castor chair continuous use	EN 425 / ISO 4918	Pass
Thermal resistance	ISO 8302	0.0245 m ² K/W Suitable for underfloor heating. Max 27°C
Slip resistance**	AS/NZS 4586:2013	R10
Adhesive	Karndean Hi-Tack PS Adhesive when applicable. Please refer to Installation Guidelines.	
Recycling	Suitable	
	GBCA/NZGBC GreenStar Rating System	GreenTag Level 'A'; LCA Silver Plus; Best Practice PVC
	Floorscore SCS- EC10.3-2014 v4.0	Indoor air quality certified; Compliant low emitting VOC emissions.
Environmental	Indoor Air Comfort	Gold certification Compliant low emitting VOC emissions.
	Environmental Product Declaration	Product-specific Type III EPD (products with external third-party verification)
	NSF/ANSI 332	Sustainability Assessment for Resilient Floor Coverings; Silver certified product
Phthalate free	Yes	

* Subject to terms. Please see our website.

** Slip resistance is measured on ex-factory product. Slip resistance can be affected by surface contamination, use and how the product is maintained.

Ashland LLP95



Bridgeport LLP157



Size	1050mm x 250mm (41.3" x 9.85")
Thickness	4.5mm
Wear Layer	0.5mm
Bevel	No
Box Quantity	12 Planks/3.15m ²

Suitability/Application:
Commercial heavy duty use
Domestic extra heavy duty use

Slip Resistance/Result:
Oil Wet Ramp R10

Technical Specifications:
Page: 61

Size	1050mm x 250mm (41.3" x 9.85")
Thickness	4.5mm
Wear Layer	0.5mm
Bevel	No
Box Quantity	12 Planks/3.15m ²

Suitability/Application:
Commercial heavy duty use
Domestic extra heavy duty use

Slip Resistance/Result:
Oil Wet Ramp R10

Technical Specifications:
Page: 61

Waterbury LLP152



Brockton LLP153



Size	1050mm x 250mm (41.3" x 9.85")
Thickness	4.5mm
Wear Layer	0.5mm
Bevel	No
Box Quantity	12 Planks/3.15m ²

Suitability/Application:
Commercial heavy duty use
Domestic extra heavy duty use

Slip Resistance/Result:
Oil Wet Ramp R10

Technical Specifications:
Page: 61

Size	1050mm x 250mm (41.3" x 9.85")
Thickness	4.5mm
Wear Layer	0.5mm
Bevel	No
Box Quantity	12 Planks/3.15m ²

Suitability/Application:
Commercial heavy duty use
Domestic extra heavy duty use

Slip Resistance/Result:
Oil Wet Ramp R10

Technical Specifications:
Page: 61

Country Oak LLP92



Size	1050mm x 250mm (41.3" x 9.85")
Thickness	4.5mm
Wear Layer	0.5mm
Bevel	No
Box Quantity	12 Planks/3.15m ²

Suitability/Application:
Commercial heavy duty use
Domestic extra heavy duty use

Slip Resistance/Result:
Oil Wet Ramp R10

Technical Specifications:
Page: 61

Hamden LLP156



Size	1050mm x 250mm (41.3" x 9.85")
Thickness	4.5mm
Wear Layer	0.5mm
Bevel	No
Box Quantity	12 Planks/3.15m ²

Suitability/Application:
Commercial heavy duty use
Domestic extra heavy duty use

Slip Resistance/Result:
Oil Wet Ramp R10

Technical Specifications:
Page: 61

Lampione LLPI47



Budelli LLPI46



Size	1050mm x 250mm (41.3" x 9.85")
Thickness	4.5mm
Wear Layer	0.5mm
Bevel	No
Box Quantity	12 Planks/3.15m ²

Suitability/Application:
Commercial heavy duty use
Domestic extra heavy duty use

Slip Resistance/Result:
Oil Wet Ramp R10

Technical Specifications:
Page: 61

Size	1050mm x 250mm (41.3" x 9.85")
Thickness	4.5mm
Wear Layer	0.5mm
Bevel	No
Box Quantity	12 Planks/3.15m ²

Suitability/Application:
Commercial heavy duty use
Domestic extra heavy duty use

Slip Resistance/Result:
Oil Wet Ramp R10

Technical Specifications:
Page: 61

Sicilia LLPI42



Providence LLPI08



Size	1050mm x 250mm (41.3" x 9.85")
Thickness	4.5mm
Wear Layer	0.5mm
Bevel	No
Box Quantity	12 Planks/3.15m ²

Suitability/Application:
Commercial heavy duty use
Domestic extra heavy duty use

Slip Resistance/Result:
Oil Wet Ramp R10

Technical Specifications:
Page: 61

Size	1050mm x 250mm (41.3" x 9.85")
Thickness	4.5mm
Wear Layer	0.5mm
Bevel	No
Box Quantity	12 Planks/3.15m ²

Suitability/Application:
Commercial heavy duty use
Domestic extra heavy duty use

Slip Resistance/Result:
Oil Wet Ramp R10

Technical Specifications:
Page: 61

Cambridge LLPI13



Size	1050mm x 250mm (41.3" x 9.85")
Thickness	4.5mm
Wear Layer	0.5mm
Bevel	No
Box Quantity	12 Planks/3.15m ²

Suitability/Application:
Commercial heavy duty use
Domestic extra heavy duty use

Slip Resistance/Result:
Oil Wet Ramp R10

Technical Specifications:
Page: 61

Levanzo LLP150



Size	1050mm x 250mm (41.3" x 9.85")
Thickness	4.5mm
Wear Layer	0.5mm
Bevel	No
Box Quantity	12 Planks/3.15m ²

Suitability/Application:
Commercial heavy duty use
Domestic extra heavy duty use

Slip Resistance/Result:
Oil Wet Ramp R10

Technical Specifications:
Page: 61

Stamford LLP109



Vintage Timber LLP105



Size	1050mm x 250mm (41.3" x 9.85")
Thickness	4.5mm
Wear Layer	0.5mm
Bevel	No
Box Quantity	12 Planks/3.15m ²

Suitability/Application:
Commercial heavy duty use
Domestic extra heavy duty use

Slip Resistance/Result:
Oil Wet Ramp R10

Technical Specifications:
Page: 61

Size	1050mm x 250mm (41.3" x 9.85")
Thickness	4.5mm
Wear Layer	0.5mm
Bevel	No
Box Quantity	12 Planks/3.15m ²

Suitability/Application:
Commercial heavy duty use
Domestic extra heavy duty use

Slip Resistance/Result:
Oil Wet Ramp R10

Technical Specifications:
Page: 61

Hartford LLP112



Danbury LLP154



Size	1050mm x 250mm (41.3" x 9.85")
Thickness	4.5mm
Wear Layer	0.5mm
Bevel	No
Box Quantity	12 Planks/3.15m ²

Suitability/Application:
Commercial heavy duty use
Domestic extra heavy duty use

Slip Resistance/Result:
Oil Wet Ramp R10

Technical Specifications:
Page: 61

Size	1050mm x 250mm (41.3" x 9.85")
Thickness	4.5mm
Wear Layer	0.5mm
Bevel	No
Box Quantity	12 Planks/3.15m ²

Suitability/Application:
Commercial heavy duty use
Domestic extra heavy duty use

Slip Resistance/Result:
Oil Wet Ramp R10

Technical Specifications:
Page: 61

Heritage Oak LLP102



Size	1050mm x 250mm (41.3" x 9.85")
Thickness	4.5mm
Wear Layer	0.5mm
Bevel	No
Box Quantity	12 Planks/3.15m ²

Suitability/Application:
Commercial heavy duty use
Domestic extra heavy duty use

Slip Resistance/Result:
Oil Wet Ramp R10

Technical Specifications:
Page: 61

Linosa LLP148



Size	1050mm x 250mm (41.3" x 9.85")
Thickness	4.5mm
Wear Layer	0.5mm
Bevel	No
Box Quantity	12 Planks/3.15m ²

Suitability/Application:
Commercial heavy duty use
Domestic extra heavy duty use

Slip Resistance/Result:
Oil Wet Ramp R10

Technical Specifications:
Page: 61

LooseLay Originals Stone



500mm x 610mm (19.7" x 24")

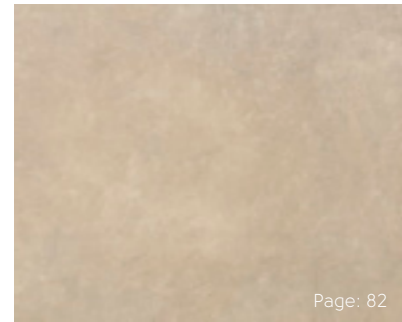

Maine **LLT213**

Page: 82

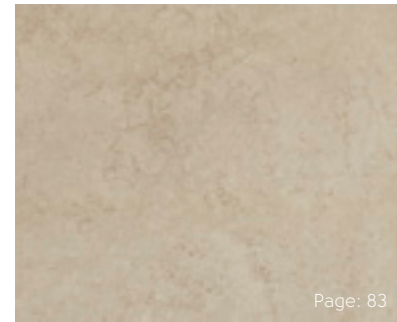

Capri **LLT209**

Page: 83

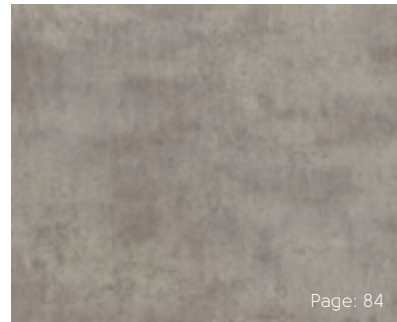

Colorado **LLT201**

Page: 84

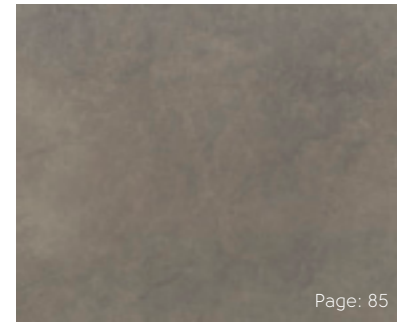

Dakota **LLT212**

Page: 85

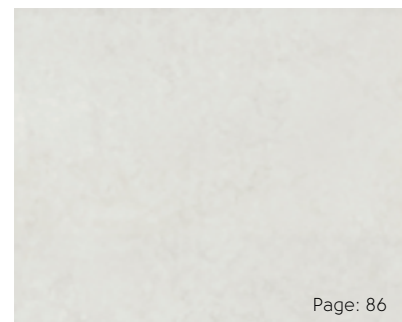

Tino **LLT208**

Page: 86

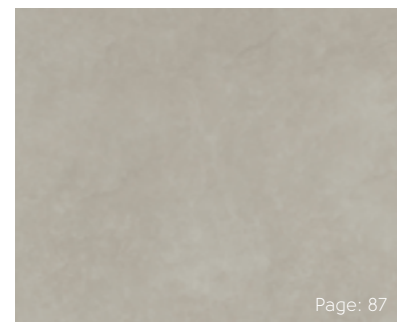

Quebec **LLT219**

Page: 87

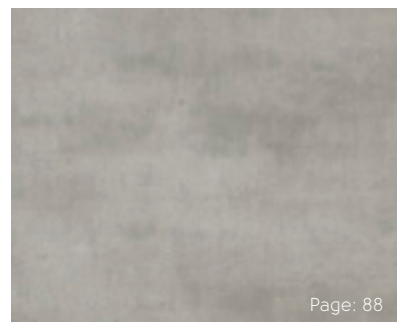

Utah **LLT216**

Page: 88

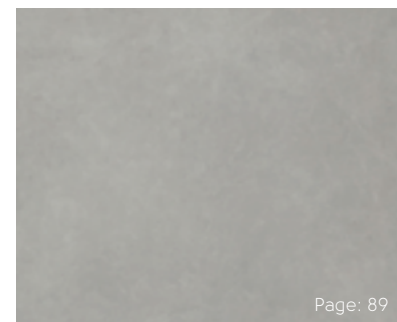

Ontario **LLT218**

Page: 89

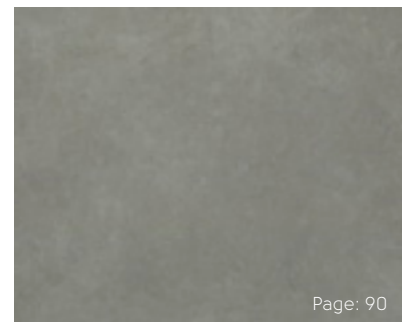

Nisida **LLT210**

Page: 90

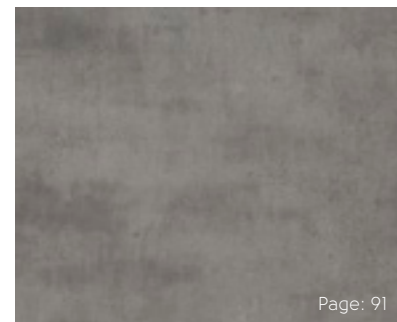

Vermont **LLT217**

Page: 91

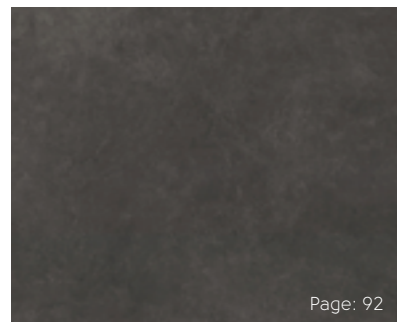

Vulcano **LLT211**

Page: 92

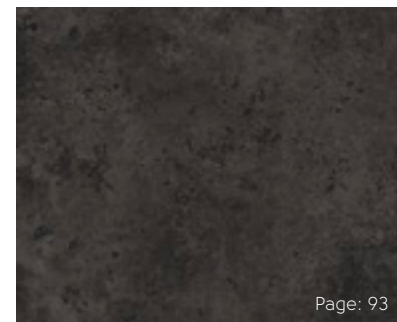

Madison **LLT203**

Page: 93

LooseLay Originals Stone

Karndean LooseLay is an innovative format of luxury vinyl flooring featuring a friction grip backing that holds the product in place without the need for clicking or locking. It's easy to install, boasts enhanced acoustic properties and is 100% recyclable. In some spaces we do recommend the use of a tackifier. Please see our website for details.

The collection features ten distinctive designs, including poured concrete, travertine and textile effects.



□ Nisida **LLT210**

Maine LLT213



Capri LLT209



Size	500mm x 610mm (19.7" x 24")
Thickness	4.5mm
Wear Layer	0.5mm
Bevel	No
Box Quantity	10 Tiles/3.05m ²

Suitability/Application:
Commercial heavy duty use
Domestic extra heavy duty use

Slip Resistance/Result:
Oil Wet Ramp R9

Technical Specifications:
Page: 81

Size	500mm x 610mm (19.7" x 24")
Thickness	4.5mm
Wear Layer	0.5mm
Bevel	No
Box Quantity	10 Tiles/3.05m ²

Suitability/Application:
Commercial heavy duty use
Domestic extra heavy duty use

Slip Resistance/Result:
Oil Wet Ramp R9

Technical Specifications:
Page: 81

Colorado LLT201



Dakota LLT212



Size	500mm x 610mm (19.7" x 24")
Thickness	4.5mm
Wear Layer	0.5mm
Bevel	No
Box Quantity	10 Tiles/3.05m ²

Suitability/Application:
Commercial heavy duty use
Domestic extra heavy duty use

Slip Resistance/Result:
Oil Wet Ramp R9

Technical Specifications:
Page: 81

Size	500mm x 610mm (19.7" x 24")
Thickness	4.5mm
Wear Layer	0.5mm
Bevel	No
Box Quantity	10 Tiles/3.05m ²

Suitability/Application:
Commercial heavy duty use
Domestic extra heavy duty use

Slip Resistance/Result:
Oil Wet Ramp R9

Technical Specifications:
Page: 81

Tino LLT208



Quebec LLT219



Size	500mm x 610mm (19.7" x 24")
Thickness	4.5mm
Wear Layer	0.5mm
Bevel	No
Box Quantity	10 Tiles/3.05m ²

Suitability/Application:
Commercial heavy duty use
Domestic extra heavy duty use

Slip Resistance/Result:
Oil Wet Ramp R9

Technical Specifications:
Page: 81

Size	500mm x 610mm (19.7" x 24")
Thickness	4.5mm
Wear Layer	0.5mm
Bevel	No
Box Quantity	10 Tiles/3.05m ²

Suitability/Application:
Commercial heavy duty use
Domestic extra heavy duty use

Slip Resistance/Result:
Oil Wet Ramp R9

Technical Specifications:
Page: 81

Utah LLT216



Ontario LLT218



Size	500mm x 610mm (19.7" x 24")
Thickness	4.5mm
Wear Layer	0.5mm
Bevel	No
Box Quantity	10 Tiles/3.05m ²

Suitability/Application:
Commercial heavy duty use
Domestic extra heavy duty use

Slip Resistance/Result:
Oil Wet Ramp R9

Technical Specifications:
Page: 81

Size	500mm x 610mm (19.7" x 24")
Thickness	4.5mm
Wear Layer	0.5mm
Bevel	No
Box Quantity	10 Tiles/3.05m ²

Suitability/Application:
Commercial heavy duty use
Domestic extra heavy duty use

Slip Resistance/Result:
Oil Wet Ramp R9

Technical Specifications:
Page: 81

Nisida LLT210



Vermont LLT217



Size	500mm x 610mm (19.7" x 24")
Thickness	4.5mm
Wear Layer	0.5mm
Bevel	No
Box Quantity	10 Tiles/3.05m ²

Suitability/Application:
Commercial heavy duty use
Domestic extra heavy duty use

Slip Resistance/Result:
Oil Wet Ramp R9

Technical Specifications:
Page: 81

Size	500mm x 610mm (19.7" x 24")
Thickness	4.5mm
Wear Layer	0.5mm
Bevel	No
Box Quantity	10 Tiles/3.05m ²

Suitability/Application:
Commercial heavy duty use
Domestic extra heavy duty use

Slip Resistance/Result:
Oil Wet Ramp R9

Technical Specifications:
Page: 81

Vulcano LLT211



Madison LLT203



Size	500mm x 610mm (19.7" x 24")
Thickness	4.5mm
Wear Layer	0.5mm
Bevel	No
Box Quantity	10 Tiles/3.05m ²

Suitability/Application:
Commercial heavy duty use
Domestic extra heavy duty use

Slip Resistance/Result:
Oil Wet Ramp R9

Technical Specifications:
Page: 81

Size	500mm x 610mm (19.7" x 24")
Thickness	4.5mm
Wear Layer	0.5mm
Bevel	No
Box Quantity	10 Tiles/3.05m ²

Suitability/Application:
Commercial heavy duty use
Domestic extra heavy duty use

Slip Resistance/Result:
Oil Wet Ramp R9

Technical Specifications:
Page: 81



Rigid core



Mezzo Grigio RKT2415



Warm Spotted Gum RKP8118



Weathered Spotted Gum RKP8119



InteGrout™

Urban Grey RKT3014-G



Australian Ghost Gum RKP8120

Baltic Mistral Oak RKP8112



■ Washed Blackbutt VGW129T



■ French Oak VGW85T

Wood at a glance (rigid core only)

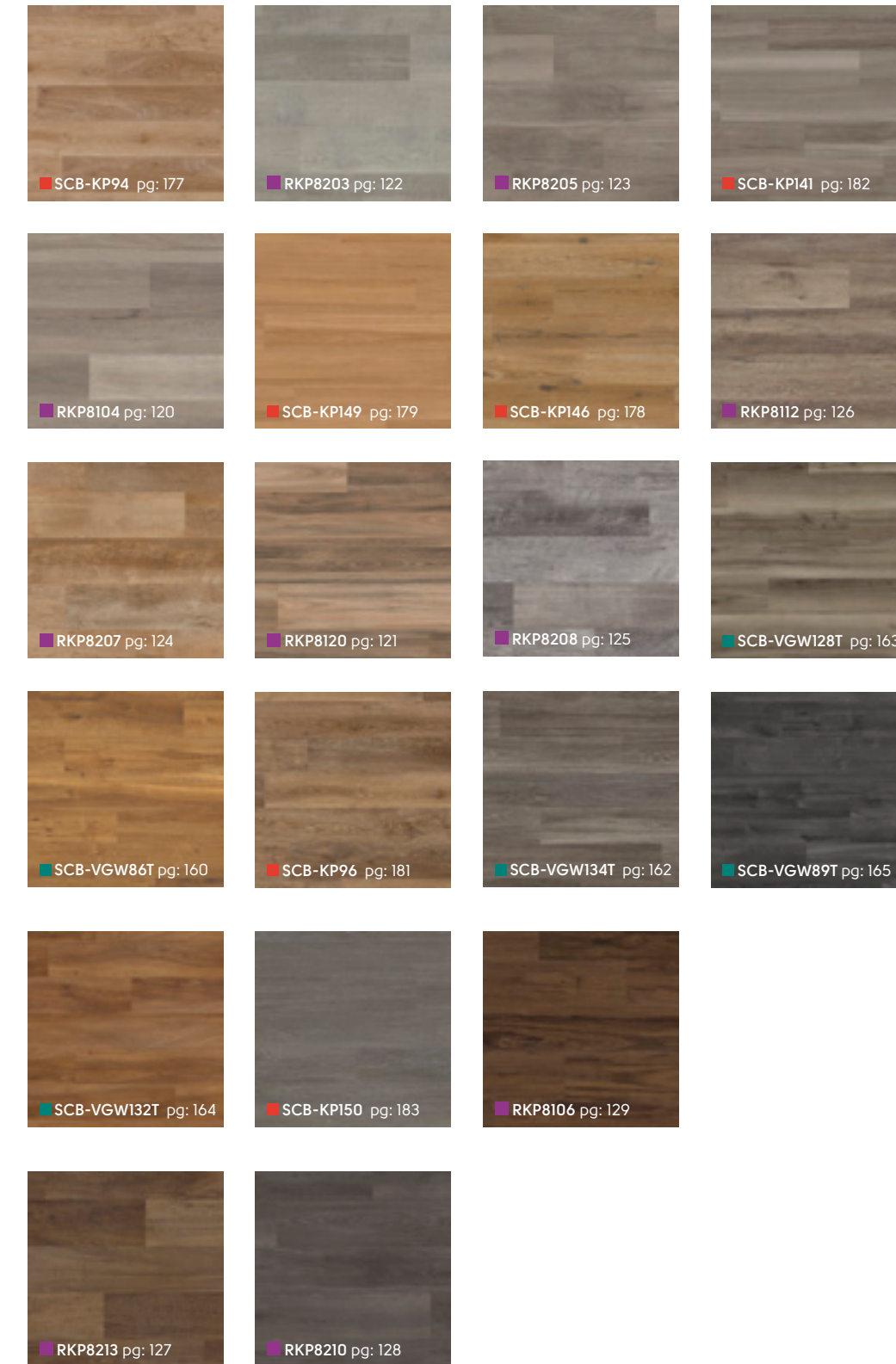
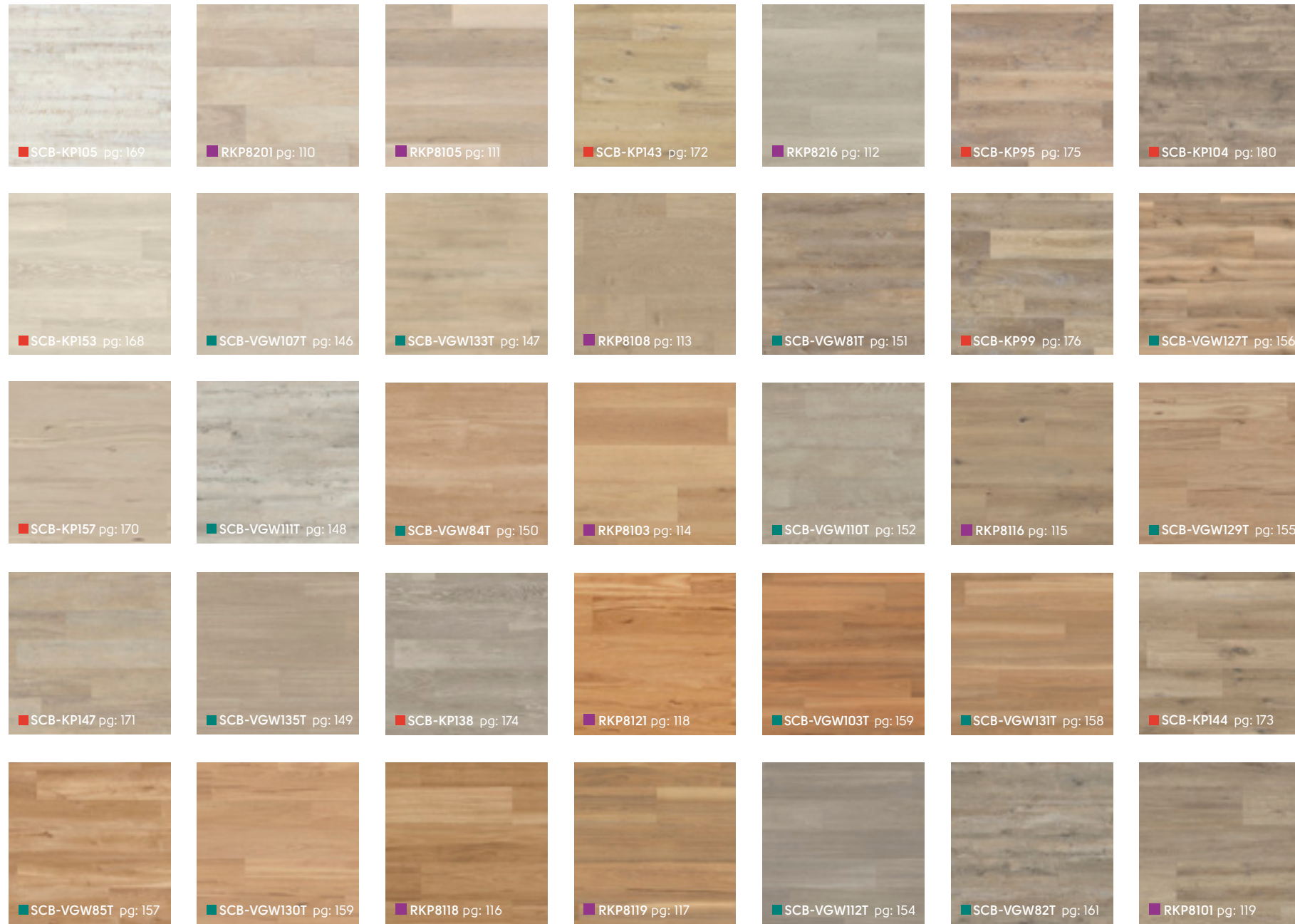

Pattern guide

Create an eye-catching design with Korlok. Our planks are multi-directional, allowing you to create a layout that adds visual interest to any space.

Bring your pattern ideas to life using our Digital Specification Library (www.karndean.com/floorstyle) or contact your commercial business manager for more information on incorporating these designs into a future project.

Staggered straight

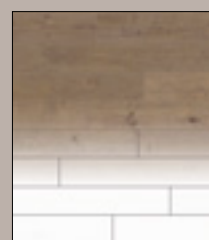

Striped diagonal

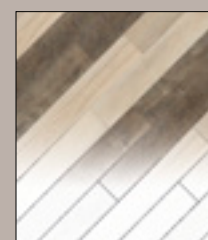





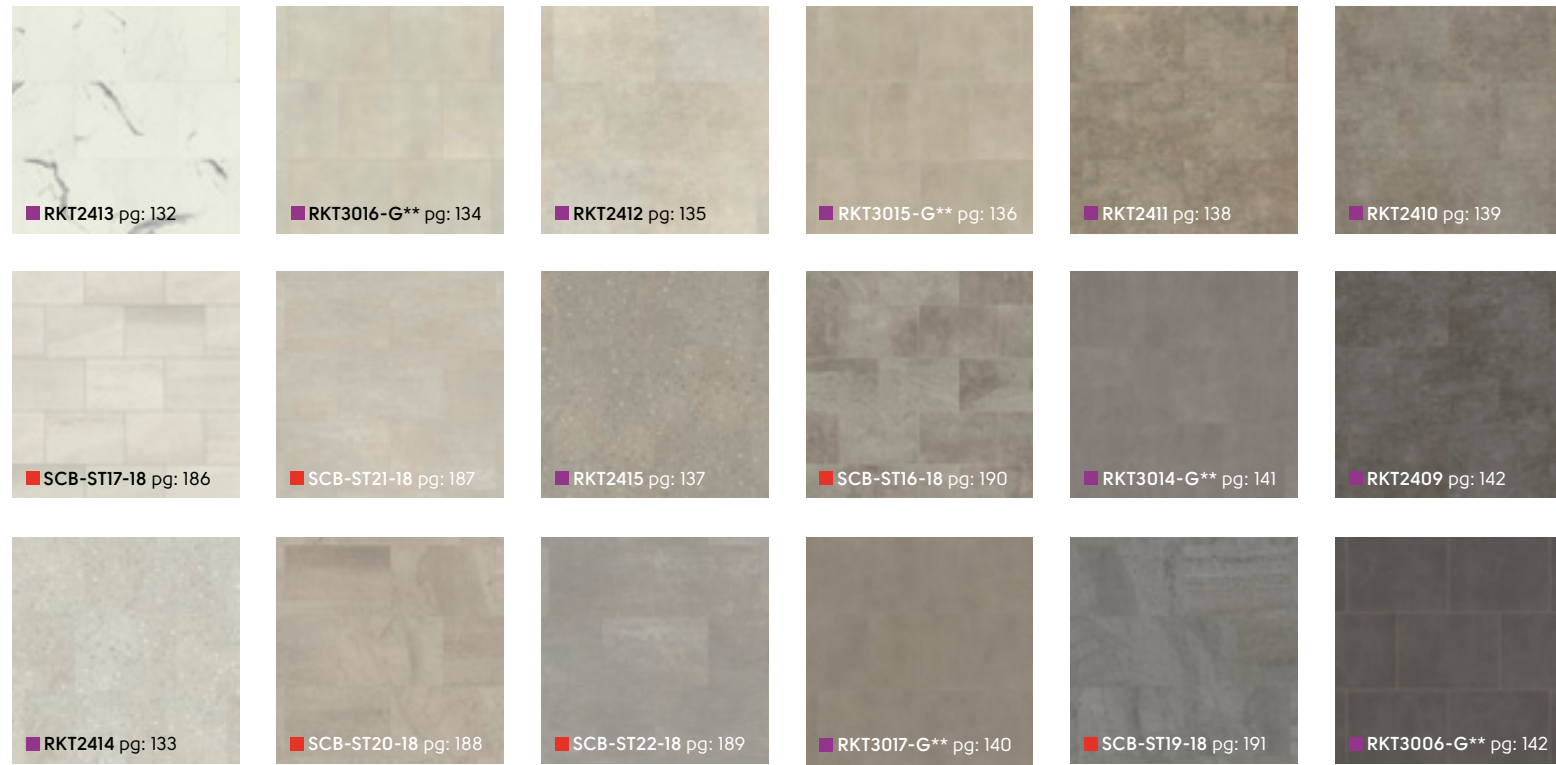

















Baltic Washed Oak RKP8101

Stone at a glance (rigid core only)



■ Grey Riven Slate SCB-ST16-18

Technical overview (rigid core only)

	Standard	Korklok (see page: 108)	Van Gogh (see page: 144)
 Size		See individual product pages	1220 x 180 mm (48" x 7")
 Thickness	ISO 24346	6.5 mm	5.5 mm
 Wear layer	ISO 24340	0.50 mm	0.50 mm
Locking system*		5G® Fold Down installation system	5G® Fold Down installation system
Surface treatment		K-Guard+ PU coating	K-Guard+ PU coating
Warranty	Commercial Domestic	15 year wear** Lifetime wear**	15 year wear** Lifetime wear**
 Bevelled edge		Micro	Micro
 Standards	EN 16511	Pass: Multilayer modular floorcovering panels	Pass: Multilayer modular floorcovering panels
 Classification	ISO 10874 Commercial ISO 10874 Domestic	33: Commercial heavy duty use 23: Domestic heavy duty use	Please refer to Customer Service for current result
 Reaction to fire	AS/NZS 9239.1:2003	Planks: CRF: 6.8 kW/m ² Smoke value: 154% min.	Tiles: CRF: 8.0 kW/m ² Smoke value: 292% min.
 Staining	EN 438-2	Pass (grade 5)	Pass (grade 5)
 Light fastness	EN ISO 105-B02	Pass ≥6	Pass ≥6
 Abrasion resistance	EN13329 Annex E	Pass 4000 cycles	Pass <4000 cycles
 Furniture chair leg	EN 424	Pass (no visible damage)	Pass (no visible damage)
 Dimensional stability	BS EN ISO 23999	Pass ≤0.25%	Pass ≤0.25%
 Swelling	ISO 24336	Pass (0.2%)	Pass (0.2%)
 Acoustic impact noise reduction	EN ISO 10140-1:2016 and EN ISO 10140-3:2010+A1:2015	ΔL _w = 21 dB	ΔL _w = 21 dB
	NCC F5.3(a) requirement of <62 dB under ISO 717.2:2013	Planks: Ln,w = 52 dB	Tiles: Ln,w = 55 dB
	G6.3.2 impact insulation class >S5 IIC	Pass	Pass
	ASTM E492-09	IIC 62	66 dB IIC
	Suitable for use on upper floors of residential high rise apartment buildings without the need for a separate acoustic underlay.		
 Indentation - residual	ISO 24343-1	≤0.1 mm	Pass ≤0.1 mm
 Impact resistance	EN13329 Annex F	Pass ≥1800 mm	Pass ≥1800 mm
 Castor chair continuous use	ISO 4918/ EN 425	Pass 25000 cycles	Please refer to Customer Service for current result
Thermal resistance	ISO 8302	0.0515 m ² /K/W. Suitable for underfloor heating, max 27 °C.	0.0515 m ² /K/W. Suitable for underfloor heating max 27 °C
 Slip resistance***	AS4586:2013 Appendix D	R10	R10
 Environmental	Floorscore SCS- EC10.3-2014 v4.0	Indoor air quality certified; Compliant low emitting VOC emissions.	Indoor air quality certified; Compliant low emitting VOC emissions.
	Indoor Air Comfort	Gold certification Compliant low emitting VOC emissions.	
	Environmental Product Declaration	Product-specific Type III EPD (products with external third-party verification)	
	NSF/ANSI 332	Sustainability Assessment for Resilient Floor Coverings; Silver certified product	
 Adhesive		None required; please install according to our installation instructions.	None required; please install according to our installation instructions.
 Recycling		Suitable	Suitable
 Phthalate free		Yes	Yes

* 5G® is a patented technology invented by Välinge Innovation AB. The 5G® word mark and logo are registered trademarks owned by Välinge Innovation AB and any use of such marks is under license.

** Subject to terms. Please see our website.

*** Slip resistance is measured on freestanding ex-factory product. Slip resistance can be affected by many factors including but not limited to: product installation and underlayment, surface contamination, use, wear and how the product is maintained. Textural variation along the surface of the product can affect nominal values.

Knight Tile (see page: 166)

See individual product pages
4.5 mm
0.3 mm
2GTM angling installation system
K-Guard+ PU coating
10 year wear** Lifetime wear**
No
Pass: Multilayer modular floorcovering panels
31: Commercial moderate 23: Domestic heavy
CRF: 10.1 kW/m ² Smoke value: 171% min
Pass (grade 5)
Pass (≥ 6)
Pass (> 10 000 cycles)
Pass (no visible damage)
Pass (≤ 0.25%)
Pass (0.2%)
ΔL _w = 19 dB
-
-
-
Pass (≤ 0.1 mm)
Pass (≥ 1800 mm)
Pass (10 000 cycles)
0.0338 m ² /K/W. Suitable for underfloor heating max 27 °C
R10 Wood R9 Stone
Indoor air quality certified; Compliant low emitting VOC emissions.
None required; please install according to our installation instructions.
Suitable
Yes



Korlok Wood



1420mm x 225mm (56" x 9")



Frosted Acacia **RKP8201**



Texas White Ash **RKP8105**



Grey Brushed Oak **RKP8216**

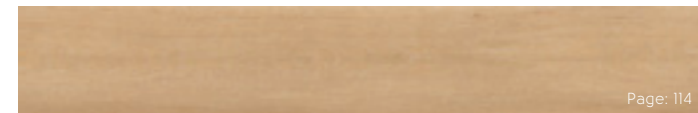

Warm Ash **RKP8103**



Washed Butternut **RKP8108**



Canadian Urban Oak **RKP8116**



Warm Spotted Gum **RKP8118**



Weathered Spotted Gum **RKP8119**



Natural Blackbutt **RKP8121**



Baltic Washed Oak **RKP8101**



Washed Grey Ash **RKP8104**



Shadow Oak **RKP8203**



Silver Barnwood **RKP8208**



Nimbus Oak **RKP8205**



Australian Ghost Gum **RKP8120**



Light Barnwood **RKP8207**



Baltic Mistral Oak **RKP8112**



Stained Acacia **RKP8213**

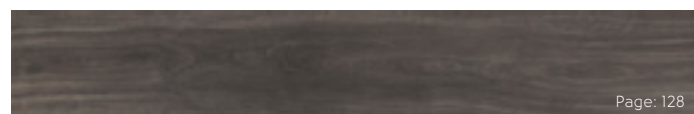

Carbon Oak **RKP8210**

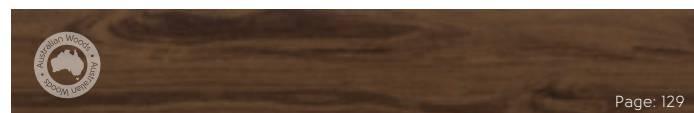

Smoked Blackbutt **RKP8106**

Korlok Wood



Korlok benefits from being easy to install over most existing hard floors, fitting over imperfect subfloors, and the pre-attached acoustic backing means there is no need for a separate underlay. With excellent acoustic properties, Korlok reduces noise transfer to rooms below making it ideal for upstairs rooms, apartments and office blocks. Native Australian species featured heavily in this range with Spotted Gum, Blackbutt and Ghost Gum all represented.



Silver Barnwood RKP8208

	Standard	Result
Size		1420 mm x 225 mm
Thickness	ISO 24346	6.5 mm
Wear layer	ISO 24340	0.50 mm
Locking system*		5G®
Surface treatment		K-Guard+ PU coating
Warranty	Commercial Domestic	15 year wear** Lifetime wear**
Bevelled edge		Micro
Mass	ISO 23997	7480 g m ⁻²
Standards	EN 16511	Pass: Multilayer modular floorcovering panels
Classification	ISO 10874 Commercial ISO 10874 Domestic	33: Commercial heavy duty use 23: Domestic heavy duty use
Reaction to fire	AS/NZS 9239.1:2003	CRF: 6.8 kW/m ² Smoke value: 154% min
Staining	EN 438-2	Pass (grade 5)
Light fastness	EN ISO 105-B02	Pass ≥6
Abrasion resistance	EN13329 Annex E	Pass 4000 cycles
Furniture chair leg	EN 424	Pass (no visible damage)
Dimensional stability	BS EN ISO 23999	Pass ≤0.25%
Swelling	ISO 24336	Pass (0.2%)
Acoustic impact noise reduction	EN ISO 10140-1:2016 and EN ISO 10140-3:2010+A1:2015	ΔL _w = 19 dB
	NCC F5.3(a) requirement of <62 dB under ISO 717.2:2013	L _{n,w} = 52 dB
	G6.3.2 impact insulation class >S5 IIC	Pass
	ASTM E492-09	IIC 62
	Suitable for use on upper floors of residential high rise apartment buildings without the need for a separate acoustic underlay.	
Indentation - residual	ISO 24343-1	≤0.1 mm
Impact resistance	EN13329 Annex F	Pass ≥1800 mm
Castor chair continuous use	ISO 4918/ EN 425	Pass 25000 cycles
Thermal resistance	ISO 8302	0.052 m ² K/W Suitable for underfloor heating max 27°C
Slip resistance***	AS4586:2013 Appendix D	R10
Environmental	Floorscore SCS-EC10.3-2014 v4.0	Indoor air quality certified, Compliant low emitting VOC emissions.
	Indoor Air Comfort	Gold certification
	Environmental Product Declaration NSF/ANSI 332	Compliant low emitting VOC emissions.* Product-specific Type III EPD (products with external third-party verification) Sustainability Assessment for Resilient Floor Coverings; Silver certified product
Adhesive		None required; please install according to our installation instructions.
Recycling		Suitable
Phthalate free		Yes

* 5G® is a patented technology invented by Välinge Innovation AB. The 5G® word mark and logo are registered trademarks owned by Välinge Innovation AB and any use of such marks is under license.
 ** Subject to terms. Please see our website.
 *** Slip resistance is measured on freestanding ex-factory product. Slip resistance can be affected by many factors including but not limited to: product installation and underlayment, surface contamination, use, wear and how the product is maintained. Textural variation along the surface of the product can affect nominal values.

Frosted Acacia RKP8201



Texas White Ash RKP8105



Size	1420mm x 225mm (56" x 9")
Thickness	6.5mm
Wear Layer	0.5mm
Bevel	Micro
Box Quantity	10 Planks/3.19m ²

Suitability/Application:
Commercial heavy duty use
Domestic heavy duty use

Slip Resistance/Result:
R10

Technical Specifications:
Page: 109

Size	1420mm x 225mm (56" x 9")
Thickness	6.5mm
Wear Layer	0.5mm
Bevel	Micro
Box Quantity	10 Planks/3.19m ²

Suitability/Application:
Commercial heavy duty use
Domestic heavy duty use

Slip Resistance/Result:
R10

Technical Specifications:
Page: 109

Grey Brushed Oak RKP8216



Washed Butternut RKP8108



Size	1420mm x 225mm (56" x 9")
Thickness	6.5mm
Wear Layer	0.5mm
Bevel	Micro
Box Quantity	10 Planks/3.19m ²

Suitability/Application:
Commercial heavy duty use
Domestic heavy duty use

Slip Resistance/Result:
R10

Technical Specifications:
Page: 109

Size	1420mm x 225mm (56" x 9")
Thickness	6.5mm
Wear Layer	0.5mm
Bevel	Micro
Box Quantity	10 Planks/3.19m ²

Suitability/Application:
Commercial heavy duty use
Domestic heavy duty use

Slip Resistance/Result:
R10

Technical Specifications:
Page: 109

Warm Ash RKP8103



Canadian Urban Oak RKP8116



Size	1420mm x 225mm (56" x 9")
Thickness	6.5mm
Wear Layer	0.5mm
Bevel	Micro
Box Quantity	10 Planks/3.19m ²

Suitability/Application:
Commercial heavy duty use
Domestic heavy duty use

Slip Resistance/Result:
R10

Technical Specifications:
Page: 109

Size	1420mm x 225mm (56" x 9")
Thickness	6.5mm
Wear Layer	0.5mm
Bevel	Micro
Box Quantity	10 Planks/3.19m ²

Suitability/Application:
Commercial heavy duty use
Domestic heavy duty use

Slip Resistance/Result:
R10

Technical Specifications:
Page: 109

Warm Spotted Gum RKP8118



Size	1420mm x 225mm (56" x 9")
Thickness	6.5mm
Wear Layer	0.5mm
Bevel	Micro
Box Quantity	10 Planks/3.19m ²

Suitability/Application:
Commercial heavy duty use
Domestic heavy duty use

Slip Resistance/Result:
R10

Technical Specifications:
Page: 109

Weathered Spotted Gum RKP8119



Size	1420mm x 225mm (56" x 9")
Thickness	6.5mm
Wear Layer	0.5mm
Bevel	Micro
Box Quantity	10 Planks/3.19m ²

Suitability/Application:
Commercial heavy duty use
Domestic heavy duty use

Slip Resistance/Result:
R10

Technical Specifications:
Page: 109

Natural Blackbutt RKP8121



Size	1420mm x 225mm (56" x 9")
Thickness	6.5mm
Wear Layer	0.5mm
Bevel	Micro
Box Quantity	10 Planks/3.19m ²

Suitability/Application:
Commercial heavy duty use
Domestic heavy duty use

Slip Resistance/Result:
R10

Technical Specifications:
Page: 109

Baltic Washed Oak RKP8101



Size	1420mm x 225mm (56" x 9")
Thickness	6.5mm
Wear Layer	0.5mm
Bevel	Micro
Box Quantity	10 Planks/3.19m ²

Suitability/Application:
Commercial heavy duty use
Domestic heavy duty use

Slip Resistance/Result:
R10

Technical Specifications:
Page: 109

Washed Grey Ash RKP8104



Australian Ghost Gum RKP8120



Size	1420mm x 225mm (56" x 9")
Thickness	6.5mm
Wear Layer	0.5mm
Bevel	Micro
Box Quantity	10 Planks/3.19m ²

Suitability/Application:
Commercial heavy duty use
Domestic heavy duty use

Slip Resistance/Result:
R10

Technical Specifications:
Page: 109

Size	1420mm x 225mm (56" x 9")
Thickness	6.5mm
Wear Layer	0.5mm
Bevel	Micro
Box Quantity	10 Planks/3.19m ²

Suitability/Application:
Commercial heavy duty use
Domestic heavy duty use

Slip Resistance/Result:
R10

Technical Specifications:
Page: 109

Shadow Oak RKP8203



Nimbus Oak RKP8205



Size	1420mm x 225mm (56" x 9")
Thickness	6.5mm
Wear Layer	0.5mm
Bevel	Micro
Box Quantity	10 Planks/3.19m ²

Suitability/Application:
Commercial heavy duty use
Domestic heavy duty use

Slip Resistance/Result:
R10

Technical Specifications:
Page: 109

Size	1420mm x 225mm (56" x 9")
Thickness	6.5mm
Wear Layer	0.5mm
Bevel	Micro
Box Quantity	10 Planks/3.19m ²

Suitability/Application:
Commercial heavy duty use
Domestic heavy duty use

Slip Resistance/Result:
R10

Technical Specifications:
Page: 109

Light Barnwood RKP8207



Silver Barnwood RKP8208



Size	1420mm x 225mm (56" x 9")
Thickness	6.5mm
Wear Layer	0.5mm
Bevel	Micro
Box Quantity	10 Planks/3.19m ²

Suitability/Application:
Commercial heavy duty use
Domestic heavy duty use

Slip Resistance/Result:
R10

Technical Specifications:
Page: 109

Size	1420mm x 225mm (56" x 9")
Thickness	6.5mm
Wear Layer	0.5mm
Bevel	Micro
Box Quantity	10 Planks/3.19m ²

Suitability/Application:
Commercial heavy duty use
Domestic heavy duty use

Slip Resistance/Result:
R10

Technical Specifications:
Page: 109

Baltic Mistral Oak RKP8112



Size	1420mm x 225mm (56" x 9")
Thickness	6.5mm
Wear Layer	0.5mm
Bevel	Micro
Box Quantity	10 Planks/3.19m ²

Suitability/Application:
Commercial heavy duty use
Domestic heavy duty use

Slip Resistance/Result:
R10

Technical Specifications:
Page: 109

Stained Acacia RKP8213



Size	1420mm x 225mm (56" x 9")
Thickness	6.5mm
Wear Layer	0.5mm
Bevel	Micro
Box Quantity	10 Planks/3.19m ²

Suitability/Application:
Commercial heavy duty use
Domestic heavy duty use

Slip Resistance/Result:
R10

Technical Specifications:
Page: 109

Carbon Oak RKP8210



Size	1420mm x 225mm (56" x 9")
Thickness	6.5mm
Wear Layer	0.5mm
Bevel	Micro
Box Quantity	10 Planks/3.19m ²

Suitability/Application:
Commercial heavy duty use
Domestic heavy duty use

Slip Resistance/Result:
R10

Technical Specifications:
Page: 109

Smoked Blackbutt RKP8106



Size	1420mm x 225mm (56" x 9")
Thickness	6.5mm
Wear Layer	0.5mm
Bevel	Micro
Box Quantity	10 Planks/3.19m ²

Suitability/Application:
Commercial heavy duty use
Domestic heavy duty use

Slip Resistance/Result:
R10

Technical Specifications:
Page: 109

Korlok Stone



457mm x 610mm (18" x 24")

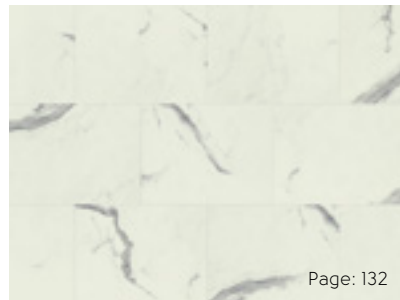

Palazzo Marble **RKT2413**

Page: 132

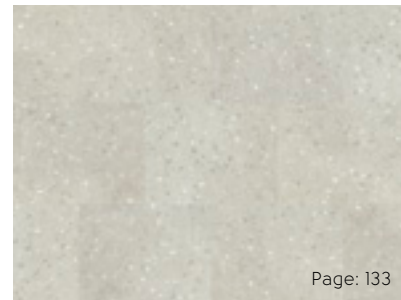

Mezzo Perla **RKT2414**

Page: 133



Pumice Stone **RKT3016-G****

Page: 134

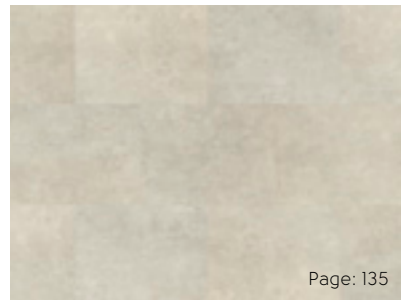

Smoke **RKT2412**

Page: 135

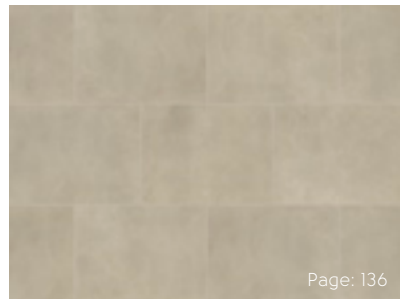

Natural Ecru **RKT3015-G****

Page: 136

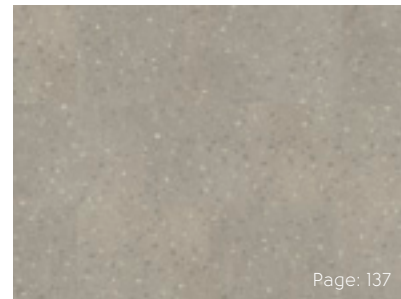

Mezzo Grigio **RKT2415**

Page: 137

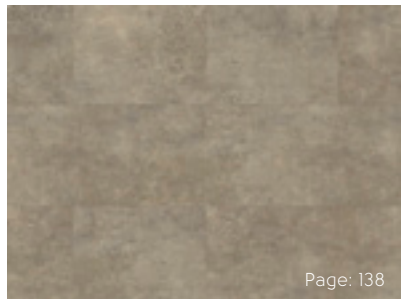

Sandstorm **RKT2411**

Page: 138

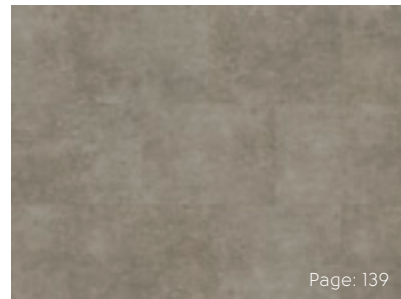

Pebble Grey **RKT2410**

Page: 139

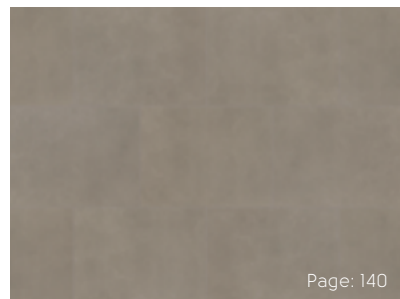

River Stone **RKT3017-G****

Page: 140

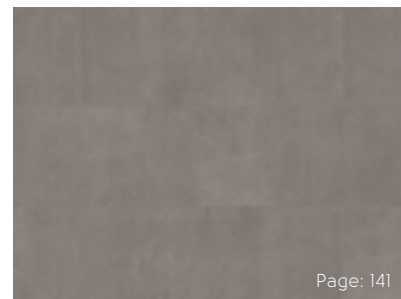

Urban Grey **RKT3014-G****

Page: 141

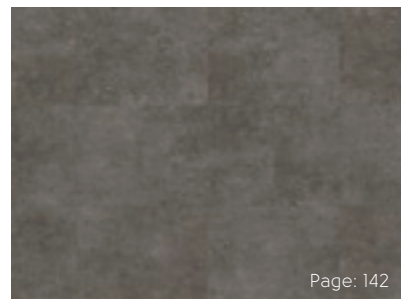

Oxford Grey **RKT2409**

Page: 142

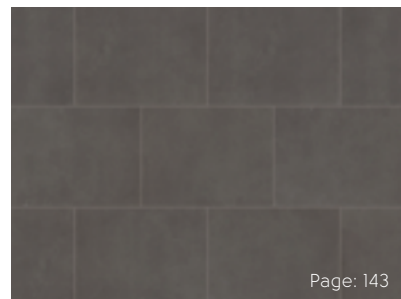

Black Sands **RKT3006-G****

Page: 143

Korlok Stone



Our Korlok stone range features 457mm x 600mm tiles with proprietary K-Core technology, a 5G® click-locking mechanism and InteGrout™ on selected designs. Together these layers form a product that is strong and stable, and able to be installed quickly and easily over most existing hard floors, as well as over imperfect subfloors. Plus, Korlok offers impressive acoustic benefits in reducing noise transfer to rooms below.



	Standard	Result
Size		1420 mm x 225 mm
Thickness	ISO 24346	6.5 mm
Wear layer	ISO 24340	0.50 mm
Locking system*		5G®
Surface treatment		K-Guard+ PU coating
Warranty	Commercial Domestic	15 year wear** Lifetime wear**
Bevelled edge		Micro
Mass	ISO 23997	7480 g m ⁻²
Standards	EN 16511	Pass: Multilayer modular floorcovering panels
Classification	ISO 10874 Commercial ISO 10874 Domestic	33: Commercial heavy duty use 23: Domestic heavy duty use
Reaction to fire	AS/NZS 9239.1:2003	CRF: 6.8 kW/m ² Smoke value: 154% min
Staining	EN 438-2	Pass (grade 5)
Light fastness	EN ISO 105-B02	Pass ≥6
Abrasion resistance	EN13329 Annex E	Pass 4000 cycles
Furniture chair leg	EN 424	Pass (no visible damage)
Dimensional stability	BS EN ISO 23999	Pass ≤0.25%
Swelling	ISO 24336	Pass (0.2%)
Acoustic impact noise reduction	EN ISO 10140-1:2016 and EN ISO 10140-3:2010+A1:2015	ΔL _w = 19 dB
	NCC F5.3(a) requirement of <62 dB under ISO 717.2:2013	L _{n,w} = 52 dB
	G6.3.2 impact insulation class >S5 IIC	Pass
	ASTM E492-09	IIC 62
	Suitable for use on upper floors of residential high rise apartment buildings without the need for a separate acoustic underlay.	
Indentation - residual	ISO 24343-1	≤0.1 mm
Impact resistance	EN13329 Annex F	Pass ≥1800 mm
Castor chair continuous use	ISO 4918/ EN 425	Pass 25000 cycles
Thermal resistance	ISO 8302	0.0515 m ² K/W Suitable for underfloor heating max 27°C
Slip resistance***	AS4586:2013 Appendix D	R10
Environmental	Floorscore SCS-EC10.3-2014 v4.0	Indoor air quality certified; Compliant low emitting VOC emissions.
	Indoor Air Comfort	Gold certification
	Environmental Product Declaration NSF/ANSI 332	Compliant low emitting VOC emissions.* Product-specific Type III EPD (products with external third-party verification) Sustainability Assessment for Resilient Floor Coverings; Silver certified product
Adhesive		None required; please install according to our installation instructions.
Recycling		Suitable
Phthalate free		Yes

* 5G® is a patented technology invented by Välinge Innovation AB. The 5G® word mark and logo are registered trademarks owned by Välinge Innovation AB and any use of such marks is under license.

** Subject to terms. Please see our website.

*** Slip resistance is measured on freestanding ex-factory product. Slip resistance can be affected by many factors including but not limited to: product installation and underlayment, surface contamination, use, wear and how the product is maintained. Textural variation along the surface of the product can affect nominal values.

Palazzo Marble RKT2413



Size	457mm x 600mm (18" x 24")
Thickness	6.5mm
Wear Layer	0.5mm
Bevel	Micro
Box Quantity	10 Tiles/2.74m ²

Suitability/Application:
Commercial heavy duty use
Domestic heavy duty use

Slip Resistance/Result:
R10

Technical Specifications:
Page: 131

Mezzo Perla RKT2414



Size	457mm x 600mm (18" x 24")
Thickness	6.5mm
Wear Layer	0.5mm
Bevel	Micro
Box Quantity	10 Tiles/2.74m ²

Suitability/Application:
Commercial heavy duty use
Domestic heavy duty use

Slip Resistance/Result:
R10

Technical Specifications:
Page: 131

Pumice Stone RKT3016-G



Size	457mm x 600mm (18" x 24")
Thickness	6.5mm
Wear Layer	0.5mm
Bevel	Micro
Box Quantity	10 Tiles/2.74m ²

Suitability/Application:
Commercial heavy duty use
Domestic heavy duty use

Slip Resistance/Result:
R10

Technical Specifications:
Page: 131

Smoke RKT2412



Size	457mm x 600mm (18" x 24")
Thickness	6.5mm
Wear Layer	0.5mm
Bevel	Micro
Box Quantity	10 Tiles/2.74m ²

Suitability/Application:
Commercial heavy duty use
Domestic heavy duty use

Slip Resistance/Result:
R10

Technical Specifications:
Page: 131

Natural Ecrú RKT3015-G



Size	457mm x 600mm (18" x 24")
Thickness	6.5mm
Wear Layer	0.5mm
Bevel	Micro
Box Quantity	10 Tiles/2.74m ²

Suitability/Application:
Commercial heavy duty use
Domestic heavy duty use

Slip Resistance/Result:
R10

Technical Specifications:
Page: 131

Mezzo Grigio RKT2415



Size	457mm x 600mm (18" x 24")
Thickness	6.5mm
Wear Layer	0.5mm
Bevel	Micro
Box Quantity	10 Tiles/2.74m ²

Suitability/Application:
Commercial heavy duty use
Domestic heavy duty use

Slip Resistance/Result:
R10

Technical Specifications:
Page: 131

Sandstorm RKT2411



Pebble Grey RKT2410



Size	457mm x 600mm (18" x 24")
Thickness	6.5mm
Wear Layer	0.5mm
Bevel	Micro
Box Quantity	10 Tiles/2.74m ²

Suitability/Application:
Commercial heavy duty use
Domestic heavy duty use

Slip Resistance/Result:
R10

Technical Specifications:
Page: 131

Size	457mm x 600mm (18" x 24")
Thickness	6.5mm
Wear Layer	0.5mm
Bevel	Micro
Box Quantity	10 Tiles/2.74m ²

Suitability/Application:
Commercial heavy duty use
Domestic heavy duty use

Slip Resistance/Result:
R10

Technical Specifications:
Page: 131

River Stone RKT3017-G



Urban Grey RKT3014-G



Size	457mm x 600mm (18" x 24")
Thickness	6.5mm
Wear Layer	0.5mm
Bevel	Micro
Box Quantity	10 Tiles/2.74m ²

Suitability/Application:
Commercial heavy duty use
Domestic heavy duty use

Slip Resistance/Result:
R10

Technical Specifications:
Page: 131

Size	457mm x 600mm (18" x 24")
Thickness	6.5mm
Wear Layer	0.5mm
Bevel	Micro
Box Quantity	10 Tiles/2.74m ²

Suitability/Application:
Commercial heavy duty use
Domestic heavy duty use

Slip Resistance/Result:
R10

Technical Specifications:
Page: 131

Oxford Grey RKT2409



Black Sands RKT3006-G



Size	457mm x 600mm (18" x 24")
Thickness	6.5mm
Wear Layer	0.5mm
Bevel	Micro
Box Quantity	10 Tiles/2.74m ²

Suitability/Application:
Commercial heavy duty use
Domestic heavy duty use

Slip Resistance/Result:
R10

Technical Specifications:
Page: 131

Size	457mm x 600mm (18" x 24")
Thickness	6.5mm
Wear Layer	0.5mm
Bevel	Micro
Box Quantity	10 Tiles/2.74m ²

Suitability/Application:
Commercial heavy duty use
Domestic heavy duty use











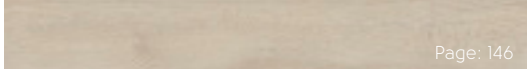





Slip Resistance/Result:
R10

Technical Specifications:
Page: 131

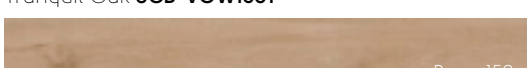

Van Gogh Wood

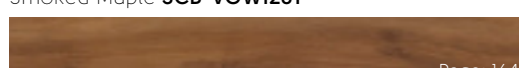
1220mm x 180mm (48" x 7")

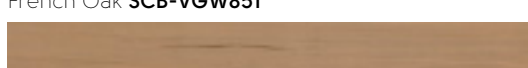
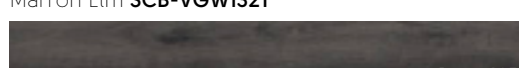
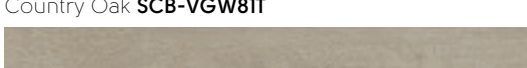
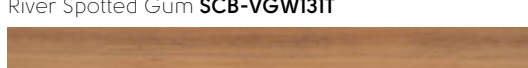
 Page: 146	 Page: 153	 Page: 160
Blush Oak SCB-VGW107T	Eastern Blackbutt SCB-VGW130T	Classic Oak SCB-VGW86T
 Page: 147	 Page: 154	 Page: 161
Millstone Sycamore SCB-VGW133T	Misty Grey Oak SCB-VGW112T	Distressed Oak SCB-VGW82T
 Page: 148	 Page: 155	 Page: 162
Light Distressed Oak SCB-VGW111T	Washed Blackbutt SCB-VGW129T	Nocturne Oak SCB-VGW134T
 Page: 209	 Page: 156	 Page: 163
Tranquil Oak SCB-VGW135T	Natural Maple SCB-VGW127T	Smoked Maple SCB-VGW128T
 Page: 150	 Page: 157	 Page: 164
Birch SCB-VGW84T	French Oak SCB-VGW85T	Marron Elm SCB-VGW132T
 Page: 151	 Page: 158	 Page: 165
Country Oak SCB-VGW81T	River Spotted Gum SCB-VGW131T	Ebony SCB-VGW89T
 Page: 152	 Page: 159	
Greige Oak SCB-VGW110T	Northern Spotted Gum SCB-VGW103T	

* Please note: as a feature of the design, these products incorporate a high colour variation between individual planks.



























Van Gogh Wood



Our collection of Van Gogh woods captures the look and feel of real timber in a variety of colour and designs from traditional rustic to cool contemporary. These large planks, distinctive grain details and subtle texture creates a style that works in both residential and commercial environments. The colour range in the Van Gogh collection offers a broad variety. From the pale tones of Blush oak to the striking dark tones of Ebony, it adds style to any space



Blush Oak VGW107T

	Standard	Result
 Size	ISO 24342	1220 x 180 mm
 Thickness	ISO 24346	5.5 mm
 Wear layer	ISO 24340	0.5 mm
 Locking system*		5G® Fold Down installation system
 Surface treatment		K-Guard+ PU coating
 Warranty	Commercial Domestic	15 year wear** Lifetime wear**
 Bevelled edge		Micro
 Standards	EN 16511	Pass: Multilayer modular floorcovering panels
 Classification	ISO 10874 Commercial ISO 10874 Domestic	33: Commercial heavy 23: Domestic heavy
 Reaction to fire	AS ISO 9239.1 2003	CRF: 10.4 kW/m ² Smoke value: 200% min
 Staining	EN 438-2	Pass (grade 5)
 Light fastness	EN ISO 105-B02	Pass ≥6
 Abrasion resistance	EN13329 Annex E	Pass <4000 cycles
 Furniture chair leg	EN 424	Pass (no visible damage)
 Dimensional stability	BS EN ISO 23999	Pass ≤0.25%
 Swelling	ISO 24336	Pass (0.2%)
 Acoustic impact noise reduction	EN ISO 10140-1:2016 and EN ISO 10140-3:2010+A1:2015 NCC F5.3(a) requirement of < 62 dB under ISO 717.2:2013 G6.3.2 impact insulation class>55 IIC ASTM E492-09	ΔL _w = 21 dB Ln,w = 56 dB Pass 66 dB IIC Suitable for use on upper floors of residential high rise apartment buildings without the need for a separate acoustic underlay.
 Indentation - residual	ISO 24343-1	Pass ≤0.1 mm
 Impact resistance	EN 13329 Annex F	Pass (≥ 1800 mm)
 Castor chair continuous use	EN 425/ISO 4918	Pass (25,000 cycles)
 Thermal resistance	ISO 8302	0.0515 m ² K/W Suitable for underfloor heating max 27 oC
 Slip resistance***	AS4586:2013 Appendix D	R10
 Environmental	Floorscore SCS-EC10.3-2014 v4.0	Indoor air quality certified; Compliant low emitting VOC emissions.
 Adhesive		None required; please install according to our installation instructions.
 Recycling		Suitable
 Phthalate free		Yes

* 5G® is a patented technology invented by Välinge Innovation AB. The 5G® word mark and logo are registered trademarks owned by Välinge Innovation AB and any use of such marks is under license.

** Subject to terms. Please see our website.

*** Slip resistance is measured on freestanding ex-factory product. Slip resistance can be affected by many factors including but not limited to: product installation and underlayment, surface contamination, use, wear and how the product is maintained. Textural variation along the surface of the product can affect nominal values.

Blush Oak SCB-VGW107T



Size	1220mm x 180mm (48" x 7")
Thickness	5.5mm
Wear Layer	0.5mm
Bevel	Micro
Box Quantity	15 Planks/3.25m ²

Suitability/Application:
Commercial heavy duty use
Domestic heavy duty use

Slip Resistance/Result:
Oil Wet Ramp R10

Technical Specifications:
Page: 145

Millstone Sycamore SCB-VGW133T



Size	1220mm x 180mm (48" x 7")
Thickness	5.5mm
Wear Layer	0.5mm
Bevel	Micro
Box Quantity	15 Planks/3.25m ²

Suitability/Application:
Commercial heavy duty use
Domestic heavy duty use

Slip Resistance/Result:
Oil Wet Ramp R10

Technical Specifications:
Page: 145

Light Distressed Oak SCB-VGW11IT



Tranquil Oak SCB-VGW135T



Size	1220mm x 180mm (48" x 7")
Thickness	5.5mm
Wear Layer	0.5mm
Bevel	Micro
Box Quantity	15 Planks/3.25m ²

Suitability/Application:
Commercial heavy duty use
Domestic heavy duty use

Slip Resistance/Result:
Oil Wet Ramp R10

Technical Specifications:
Page: 145

Size	1220mm x 180mm (48" x 7")
Thickness	5.5mm
Wear Layer	0.5mm
Bevel	Micro
Box Quantity	15 Planks/3.25m ²

Suitability/Application:
Commercial heavy duty use
Domestic heavy duty use

Slip Resistance/Result:
Oil Wet Ramp R10

Technical Specifications:
Page: 145

Birch SCB-VGW84T



Country Oak SCB-VGW81T



Size	1220mm x 180mm (48" x 7")
Thickness	5.5mm
Wear Layer	0.5mm
Bevel	Micro
Box Quantity	15 Planks/3.25m ²

Suitability/Application:
Commercial heavy duty use
Domestic heavy duty use

Slip Resistance/Result:
Oil Wet Ramp R10

Technical Specifications:
Page: 145

Size	1220mm x 180mm (48" x 7")
Thickness	5.5mm
Wear Layer	0.5mm
Bevel	Micro
Box Quantity	15 Planks/3.25m ²

Suitability/Application:
Commercial heavy duty use
Domestic heavy duty use

Slip Resistance/Result:
Oil Wet Ramp R10

Technical Specifications:
Page: 145

Greige Oak SCB-VGW110T



Eastern Blackbutt SCB-VGW130T



Size	1220mm x 180mm (48" x 7")
Thickness	5.5mm
Wear Layer	0.5mm
Bevel	Micro
Box Quantity	15 Planks/3.25m ²

Suitability/Application:
Commercial heavy duty use
Domestic heavy duty use

Slip Resistance/Result:
Oil Wet Ramp R10

Technical Specifications:
Page: 145

Size	1220mm x 180mm (48" x 7")
Thickness	5.5mm
Wear Layer	0.5mm
Bevel	Micro
Box Quantity	15 Planks/3.25m ²

Suitability/Application:
Commercial heavy duty use
Domestic heavy duty use

Slip Resistance/Result:
Oil Wet Ramp R10

Technical Specifications:
Page: 145

Misty Grey Oak SCB-VGW112T



Washed Blackbutt SCB-VGW129T



Size	1220mm x 180mm (48" x 7")
Thickness	5.5mm
Wear Layer	0.5mm
Bevel	Micro
Box Quantity	15 Planks/3.25m ²

Suitability/Application:
Commercial heavy duty use
Domestic heavy duty use

Slip Resistance/Result:
Oil Wet Ramp R10

Technical Specifications:
Page: 145

Size	1220mm x 180mm (48" x 7")
Thickness	5.5mm
Wear Layer	0.5mm
Bevel	Micro
Box Quantity	15 Planks/3.25m ²

Suitability/Application:
Commercial heavy duty use
Domestic heavy duty use

Slip Resistance/Result:
Oil Wet Ramp R10

Technical Specifications:
Page: 145

Natural Maple SCB-VGW127T



French Oak SCB-VGW85T



Size	1220mm x 180mm (48" x 7")
Thickness	5.5mm
Wear Layer	0.5mm
Bevel	Micro
Box Quantity	15 Planks/3.25m ²

Suitability/Application:
Commercial heavy duty use
Domestic heavy duty use

Slip Resistance/Result:
Oil Wet Ramp R10

Technical Specifications:
Page: 145

Size	1220mm x 180mm (48" x 7")
Thickness	5.5mm
Wear Layer	0.5mm
Bevel	Micro
Box Quantity	15 Planks/3.25m ²

Suitability/Application:
Commercial heavy duty use
Domestic heavy duty use

Slip Resistance/Result:
Oil Wet Ramp R10

Technical Specifications:
Page: 145

River Spotted Gum SCB-VGW131T



Northern Spotted Gum SCB-VGW103T



Size	1220mm x 180mm (48" x 7")
Thickness	5.5mm
Wear Layer	0.5mm
Bevel	Micro
Box Quantity	15 Planks/3.25m ²

Suitability/Application:
Commercial heavy duty use
Domestic heavy duty use

Slip Resistance/Result:
Oil Wet Ramp R10

Technical Specifications:
Page: 145

Size	1220mm x 180mm (48" x 7")
Thickness	5.5mm
Wear Layer	0.5mm
Bevel	Micro
Box Quantity	15 Planks/3.25m ²

Suitability/Application:
Commercial heavy duty use
Domestic heavy duty use

Slip Resistance/Result:
Oil Wet Ramp R10

Technical Specifications:
Page: 145

Classic Oak SCB-VGW86T



Distressed Oak SCB-VGW82T



Size	1220mm x 180mm (48" x 7")
Thickness	5.5mm
Wear Layer	0.5mm
Bevel	Micro
Box Quantity	15 Planks/3.25m ²

Suitability/Application:
Commercial heavy duty use
Domestic heavy duty use

Slip Resistance/Result:
Oil Wet Ramp R10

Technical Specifications:
Page: 145

Size	1220mm x 180mm (48" x 7")
Thickness	5.5mm
Wear Layer	0.5mm
Bevel	Micro
Box Quantity	15 Planks/3.25m ²

Suitability/Application:
Commercial heavy duty use
Domestic heavy duty use

Slip Resistance/Result:
Oil Wet Ramp R10

Technical Specifications:
Page: 145

Nocturne Oak SCB-VGW134T



Smoked Maple SCB-VGW128T



Size	1220mm x 180mm (48" x 7")
Thickness	5.5mm
Wear Layer	0.5mm
Bevel	Micro
Box Quantity	15 Planks/3.25m ²

Suitability/Application:
Commercial heavy duty use
Domestic heavy duty use

Slip Resistance/Result:
Oil Wet Ramp R10

Technical Specifications:
Page: 145

Size	1220mm x 180mm (48" x 7")
Thickness	5.5mm
Wear Layer	0.5mm
Bevel	Micro
Box Quantity	15 Planks/3.25m ²

Suitability/Application:
Commercial heavy duty use
Domestic heavy duty use

Slip Resistance/Result:
Oil Wet Ramp R10

Technical Specifications:
Page: 145

Marron Elm SCB-VGW132T



Size	1220mm x 180mm (48" x 7")
Thickness	5.5mm
Wear Layer	0.5mm
Bevel	Micro
Box Quantity	15 Planks/3.25m ²

Suitability/Application:
Commercial heavy duty use
Domestic heavy duty use

Slip Resistance/Result:
Oil Wet Ramp R10

Technical Specifications:
Page: 145

Ebony SCB-VGW89T



Size	1220mm x 180mm (48" x 7")
Thickness	5.5mm
Wear Layer	0.5mm
Bevel	Micro
Box Quantity	15 Planks/3.25m ²

Suitability/Application:
Commercial heavy duty use
Domestic heavy duty use

Slip Resistance/Result:
Oil Wet Ramp R10

Technical Specifications:
Page: 145

Knight Tile Wood



(1220mm x 180mm) 48" x 7"



Nordic Limed Oak **SCB-KP153**

Page: 168



Lime Washed Oak **SCB-KP99**

Page: 176



White Painted Oak **SCB-KP105**

Page: 169



Pale Limed Oak **SCB-KP94**

Page: 177



Coastal Blackbutt **SCB-KP157**

Page: 170



Traditional Character Oak **SCB-KP146**

Page: 178



Coastline Oak **SCB-KP147**

Page: 247



Classic Spotted Gum **SCB-KP149**

Page: 179



Blond Character Oak **SCB-KP143**

Page: 172



Light Worn Oak **SCB-KP104**

Page: 181



Washed Character Oak **SCB-KP144**

Page: 173



Mid Limed Oak **SCB-KP96**

Page: 181



Grey Limed Oak **SCB-KP138**

Page: 174



Urban Spotted Gum **SCB-KP141**

Page: 182

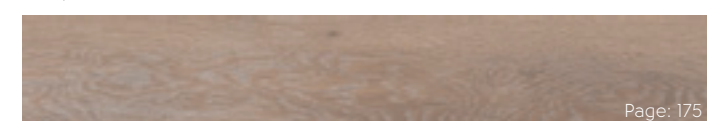

Rose Washed Oak **SCB-KP95**

Page: 175

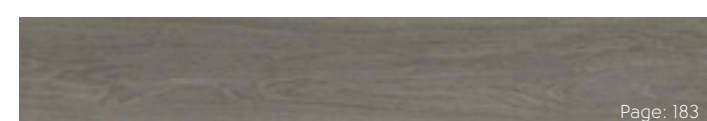

Shadow Studio Oak **SCB-KP150**

Page: 183

Knight Tile Wood

Our versatile Knight Tile collection of woods includes a wide range of tones and styles suitable for residential and light commercial installations. Each plank has been designed to reflect the grain details of natural timber. The collection includes the cool tones of Coastline Oak, the mid-tones of Mid Limed Oak and striking dark tone of Shadow Studio Oak, offering a wide variety to suite all spaces.



■ Nordic Limed Oak **SCB-KP153**

	Standard	Result
Size	ISO 24342	See individual product pages
Thickness	ISO 24346	4.5 mm
Wear layer		0.3 mm
Locking system ¹		2G™ angling installation system
Surface treatment		K-Guard+ PU coating
Warranty	Commercial Domestic	10 years wear* Lifetime wear*
Bevelled edge		No
Standards	EN 16511	Pass: Multilayer modular floorcovering panels
Classification	ISO 10874 - Commercial ISO 10874 - Domestic	31: Commercial moderate 23: Domestic heavy
Reaction to fire	AS ISO 9239.1:2003	CRF: 10.1 kW/m ² Smoke value: 171% min.
Staining	EN 438-2	Pass (Grade 5)
Light fastness	EN ISO 105-B02	Pass (≥ 6)
Abrasion resistance	EN 13329 Annex E	Pass (> 10 000 cycles)
Furniture chair leg	EN 424	Pass (No visible damage)
Dimensional stability	BS EN ISO 23999	Pass (≤ 0.25%)
Swelling	ISO 24336	Pass (0.2%)
Acoustic impact noise reduction	EN ISO 10140-1:2016	ΔL _w = 19 dB
Indentation - residual	ISO 24343-1	Pass (≤ 0.1 mm)
Impact resistance	EN 13329 Annex F	Pass (≥ 1800 mm)
Castor chair continuous use	EN 425/ISO 4918	Pass (10 000 cycles)
Thermal resistance	ISO 8302	0.0338 m ² K/W Suitable for underfloor heating. Max 27°C
Slip resistance**	AS/NZS 4586:2013	R10
Adhesive		None required; please install according to our installation instructions.
Recycling		Suitable
Environmental	Floorscore SCS-EC10.3-2014 v4.0	Indoor air quality certified; Compliant low emitting VOC emissions.
Phthalate free		Yes

¹ 2G™ is a patented technology invented by Välinge Innovation AB. The 2G™ word mark and logo are registered trademarks owned by Välinge Innovation AB and any use of such marks is under license.
* Subject to terms. Please see our website.
** Slip resistance is measured on ex-factory product. Slip resistance can be affected by surface contamination, use and how the product is maintained.

Nordic Limed Oak SCB-KPI53



White Painted Oak SCB-KPI05



Size	1220mm x 180mm (48" x 7")
Thickness	4.5mm
Wear Layer	0.3mm
Bevel	No
Box Quantity	14 Planks/3.074m ²

Suitability/Application:
Commercial light duty use
Domestic heavy duty use

Slip Resistance/Result:
Oil Wet Ramp R10

Technical Specifications:
Page: 167

Size	1220mm x 180mm (48" x 7")
Thickness	4.5mm
Wear Layer	0.3mm
Bevel	No
Box Quantity	14 Planks/3.074m ²

Suitability/Application:
Commercial light duty use
Domestic heavy duty use

Slip Resistance/Result:
Oil Wet Ramp R10

Technical Specifications:
Page: 167

Coastal Blackbutt SCB-KPI157



Coastline Oak SCB-KPI147



Size	1220mm x 180mm (48" x 7")
Thickness	4.5mm
Wear Layer	0.3mm
Bevel	No
Box Quantity	14 Planks/3.074m ²

Suitability/Application:
Commercial light duty use
Domestic heavy duty use

Slip Resistance/Result:
Oil Wet Ramp R10

Technical Specifications:
Page: 167

Size	1220mm x 180mm (48" x 7")
Thickness	4.5mm
Wear Layer	0.3mm
Bevel	No
Box Quantity	14 Planks/3.074m ²

Suitability/Application:
Commercial light duty use
Domestic heavy duty use

Slip Resistance/Result:
Oil Wet Ramp R10

Technical Specifications:
Page: 167

Blond Character Oak SCB-KPI43



Washed Character Oak SCB-KPI44



Size	1220mm x 180mm (48" x 7")
Thickness	4.5mm
Wear Layer	0.3mm
Bevel	No
Box Quantity	14 Planks/3.074m ²

Suitability/Application:
Commercial light duty use
Domestic heavy duty use

Slip Resistance/Result:
Oil Wet Ramp R10

Technical Specifications:
Page: 167

Size	1220mm x 180mm (48" x 7")
Thickness	4.5mm
Wear Layer	0.3mm
Bevel	No
Box Quantity	14 Planks/3.074m ²

Suitability/Application:
Commercial light duty use
Domestic heavy duty use

Slip Resistance/Result:
Oil Wet Ramp R10

Technical Specifications:
Page: 167

Grey Limed Oak SCB-KPI38



Rose Washed Oak SCB-KP95



Size	1220mm x 180mm (48" x 7")
Thickness	4.5mm
Wear Layer	0.3mm
Bevel	No
Box Quantity	14 Planks/3.074m ²

Suitability/Application:
Commercial light duty use
Domestic heavy duty use

Slip Resistance/Result:
Oil Wet Ramp R10

Technical Specifications:
Page: 167

Size	1220mm x 180mm (48" x 7")
Thickness	4.5mm
Wear Layer	0.3mm
Bevel	No
Box Quantity	14 Planks/3.074m ²

Suitability/Application:
Commercial light duty use
Domestic heavy duty use

Slip Resistance/Result:
Oil Wet Ramp R10

Technical Specifications:
Page: 167

Lime Washed Oak SCB-KP99



Pale Limed Oak SCB-KP94



Size	1220mm x 180mm (48" x 7")
Thickness	4.5mm
Wear Layer	0.3mm
Bevel	No
Box Quantity	14 Planks/3.074m ²

Suitability/Application:

Commercial light duty use
Domestic heavy duty use

Slip Resistance/Result:

Oil Wet Ramp R10

Technical Specifications:

Page: 167

Size	1220mm x 180mm (48" x 7")
Thickness	4.5mm
Wear Layer	0.3mm
Bevel	No
Box Quantity	14 Planks/3.074m ²

Suitability/Application:

Commercial light duty use
Domestic heavy duty use

Slip Resistance/Result:

Oil Wet Ramp R10

Technical Specifications:

Page: 167

Traditional Character Oak SCB-KPI46



Size	1220mm x 180mm (48" x 7")
Thickness	4.5mm
Wear Layer	0.3mm
Bevel	No
Box Quantity	14 Planks/3.074m ²

Suitability/Application:
Commercial light duty use
Domestic heavy duty use

Slip Resistance/Result:
Oil Wet Ramp R10

Technical Specifications:
Page: 167

Classic Spotted Gum SCB-KPI49



Size	1220mm x 180mm (48" x 7")
Thickness	4.5mm
Wear Layer	0.3mm
Bevel	No
Box Quantity	14 Planks/3.074m ²

Suitability/Application:
Commercial light duty use
Domestic heavy duty use

Slip Resistance/Result:
Oil Wet Ramp R10

Technical Specifications:
Page: 167

Light Worn Oak SCB-KP104



Mid Limed Oak SCB-KP96



Size	1220mm x 180mm (48" x 7")
Thickness	4.5mm
Wear Layer	0.3mm
Bevel	No
Box Quantity	14 Planks/3.074m ²

Suitability/Application:
Commercial light duty use
Domestic heavy duty use

Slip Resistance/Result:
Oil Wet Ramp R10

Technical Specifications:
Page: 167

Size	1220mm x 180mm (48" x 7")
Thickness	4.5mm
Wear Layer	0.3mm
Bevel	No
Box Quantity	14 Planks/3.074m ²

Suitability/Application:
Commercial light duty use
Domestic heavy duty use

Slip Resistance/Result:
Oil Wet Ramp R10

Technical Specifications:
Page: 167

Urban Spotted Gum SCB-KP141



Shadow Studio Oak SCB-KP150



Size	1220mm x 180mm (48" x 7")
Thickness	4.5mm
Wear Layer	0.3mm
Bevel	No
Box Quantity	14 Planks/3.074m ²

Suitability/Application:

Commercial light duty use
Domestic heavy duty use

Slip Resistance/Result:

Oil Wet Ramp R10

Technical Specifications:

Page: 167

Size	1220mm x 180mm (48" x 7")
Thickness	4.5mm
Wear Layer	0.3mm
Bevel	No
Box Quantity	14 Planks/3.074m ²

Suitability/Application:

Commercial light duty use
Domestic heavy duty use

Slip Resistance/Result:

Oil Wet Ramp R10

Technical Specifications:

Page: 167

Knight Tile Stone



305mm x 457mm (12" x 18")

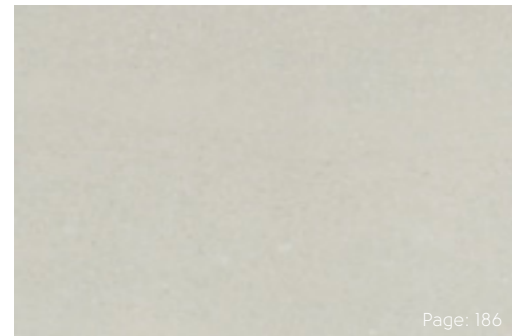

Honed Oyster Slate **SCB-ST17-18**



Dove Grey Concrete **SCB-ST21-18**

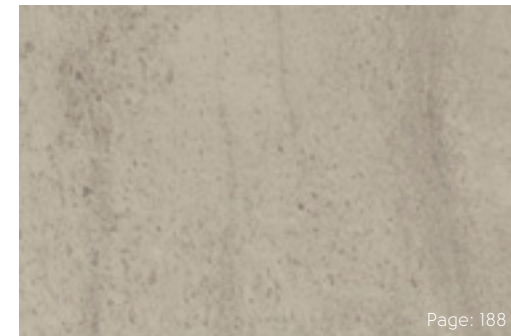

Honed Pebble Slate **SCB-ST20-18**

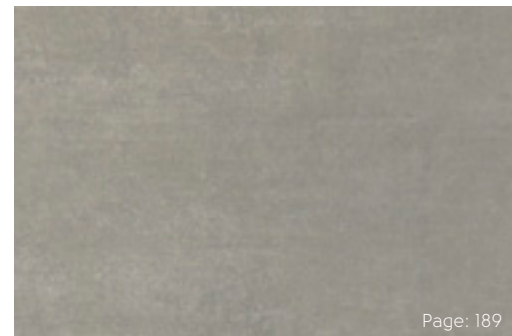

Smoked Concrete **SCB-ST22-18**



Grey Riven Slate **SCB-ST16-18**

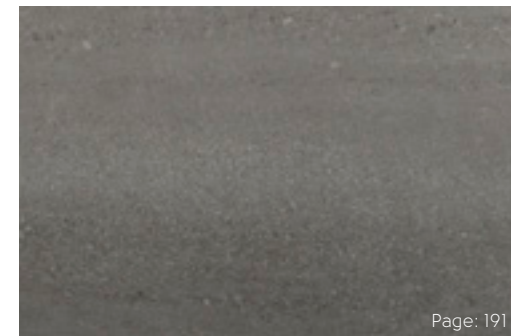

Honed Charcoal Slate **SCB-ST19-18**

Knight Tile Stone

Our Knight tile collection of stones offers a great selection of effects and styles. Each colour and design reflects a wide range of natural materials from classic pale to contemporary dark stones. The collection includes the classic tones of Grey Riven slate to the modern look of Honed Oyster Slate and the bold characteristics of Honed Charcoal Slate, giving a collection that covers a wide variety of interior styles.



	Standard	Result
Size	ISO 24342	See individual product pages
Thickness	ISO 24346	4.5 mm
Wear layer		0.3 mm
Locking system ¹		2G™ angling installation system
Surface treatment		K-Guard+ PU coating
Warranty	Commercial Domestic	10 years wear* Lifetime wear*
Bevelled edge		No
Standards	EN 16511	Pass: Multilayer modular floorcovering panels
Classification	ISO 10874 - Commercial ISO 10874 - Domestic	31: Commercial moderate 23: Domestic heavy
Reaction to fire	AS ISO 9239.1:2003	CRF: 10.1 kW/m ² Smoke value: 171% min.
Staining	EN 438-2	Pass (Grade 5)
Light fastness	EN ISO 105-B02	Pass (≥ 6)
Abrasion resistance	EN 13329 Annex E	Pass (> 10 000 cycles)
Furniture chair leg	EN 424	Pass (No visible damage)
Dimensional stability	BS EN ISO 23999	Pass (≤ 0.25%)
Swelling	ISO 24336	Pass (0.2%)
Acoustic impact noise reduction	EN ISO 10140-1:2016	ΔL _v = 19 dB
Indentation - residual	ISO 24343-1	Pass (≤ 0.1 mm)
Impact resistance	EN 13329 Annex F	Pass (≥ 1800 mm)
Castor chair continuous use	EN 425/ISO 4918	Pass (10 000 cycles)
Thermal resistance	ISO 8302	0.0338 m ² K/W Suitable for underfloor heating, Max 27°C
Slip resistance**	AS/NZS 4586:2013	R9
Adhesive		None required; please install according to our installation instructions.
Recycling		Suitable
Environmental	Floorscore SCS-EC10.3-2014 v4.0	Indoor air quality certified; Compliant low emitting VOC emissions.
Phthalate free		Yes

Smoked Concrete **SCB-ST22-18**

¹ 2G™ is a patented technology invented by Valinge Innovation AB. The 2G™ word mark and logo are registered trademarks owned by Valinge Innovation AB and any use of such marks is under license.
* Subject to terms. Please see our website.
** Slip resistance is measured on ex-factory product. Slip resistance can be affected by surface contamination, use and how the product is maintained.

Honed Oyster Slate SCB-ST17-18



Size	305mm x 457mm (12" x 18")
Thickness	4.5mm
Wear Layer	0.3mm
Bevel	No
Box Quantity	20 Tiles/2.787m ²

Suitability/Application:
Commercial moderate use
Domestic heavy duty use

Slip Resistance/Result:
Oil Wet Ramp R9

Technical Specifications:
Page: 185

Dove Grey Concrete SCB-ST21-18



Size	305mm x 457mm (12" x 18")
Thickness	4.5mm
Wear Layer	0.3mm
Bevel	No
Box Quantity	20 Tiles/2.787m ²

Suitability/Application:
Commercial moderate use
Domestic heavy duty use

Slip Resistance/Result:
Oil Wet Ramp R9

Technical Specifications:
Page: 185

Honed Pebble Slate SCB-ST20-18



Size	305mm x 457mm (12" x 18")
Thickness	4.5mm
Wear Layer	0.3mm
Bevel	No
Box Quantity	20 Tiles/2.787m ²

Suitability/Application:
Commercial moderate use
Domestic heavy duty use

Slip Resistance/Result:
Oil Wet Ramp R9

Technical Specifications:
Page: 185

Smoked Concrete SCB-ST22-18



Size	305mm x 457mm (12" x 18")
Thickness	4.5mm
Wear Layer	0.3mm
Bevel	No
Box Quantity	20 Tiles/2.787m ²

Suitability/Application:
Commercial moderate use
Domestic heavy duty use

Slip Resistance/Result:
Oil Wet Ramp R9

Technical Specifications:
Page: 185

Grey Riven Slate SCB-ST16-18



Size	305mm x 457mm (12" x 18")
Thickness	4.5mm
Wear Layer	0.3mm
Bevel	No
Box Quantity	20 Tiles/2.787m ²

Suitability/Application:
Commercial moderate use
Domestic heavy duty use

Slip Resistance/Result:
Oil Wet Ramp R9

Technical Specifications:
Page: 185

Honed Charcoal Slate SCB-ST19-18



Size	305mm x 457mm (12" x 18")
Thickness	4.5mm
Wear Layer	0.3mm
Bevel	No
Box Quantity	20 Tiles/2.787m ²

Suitability/Application:
Commercial moderate use
Domestic heavy duty use

Slip Resistance/Result:
Oil Wet Ramp R9

Technical Specifications:
Page: 185



Gluedown

Designflooring explained

There are endless design possibilities when using Karndean in commercial environments. The beauty of Karndean is that it is so versatile, you can take any of our products and, with a little imagination, create your own design. Once you've selected a floor, you can define the space and add interest to a design with our designflooring elements.

By designing the space using different product styles and integrating borders, design strips and special cuts, walkways can be created to help guide customers or visually impaired patients, entranceways can really make an impact with a custom design or zoning can be used to focus attention.



Design strips

The design strips can be placed between tiles to create a natural grouting effect or to enhance the design of the floor. Choose from a wide range of tones and textures, available in 3, 5 and 10mm widths.

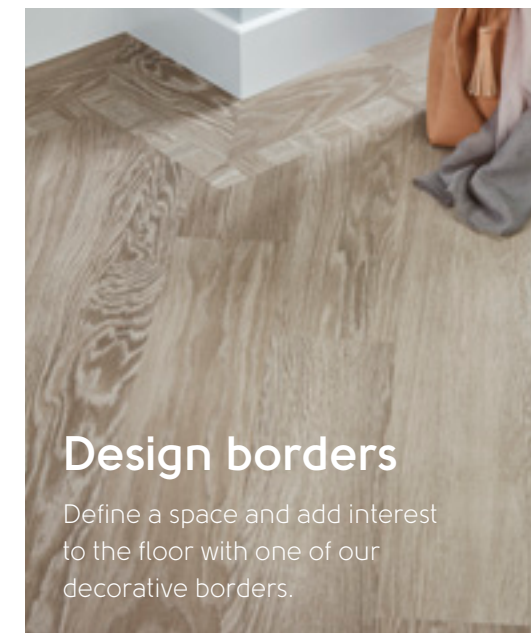

Design borders

Define a space and add interest to the floor with one of our decorative borders.

Kaleidoscope

Offering architects, interior designers and contractors the ability to explore a new world of patterns and shapes using Karndean, Kaleidoscope is a unique collection of wood, stone and solid colours available in geometric designs including Cubix, Pennon and Apex.

Individual shapes are cut from original Karndean products, meaning they retain our authentic designs and key technical specification. To view the Kaleidoscope range, go to page 281.



Designflooring in commercial environments



With increasing competition, it's more important than ever to create an engaging customer experience. In today's digital age, the floor has become the maximum impact zone due to our constant engagement with hand-held technology. Experiment with a combination of colours, sizes and textures to break up a space and add visual interest, while enhancing the overall design.

Zoning

Easily highlight key sections or displays and separate front and back of house areas by mixing products or by incorporating design strips and inlays.



Wayfinding

Flexibility in flooring allows you to add walkways and create paths that facilitate customer, resident or employee traffic flow.



Blending

Blended floors can serve many purposes, from matching a variety of tones, colours and textures to creating a custom look for your clients. Choose corresponding looks from the same product range for transition-free space planning.





■ Sundown Oak HC04



We travel the world in our quest to bring you exceptional floors.

■ Argento SP217 with DS10 5mm design strip



From the ancient forests of Europe, to the remote Australian outback.

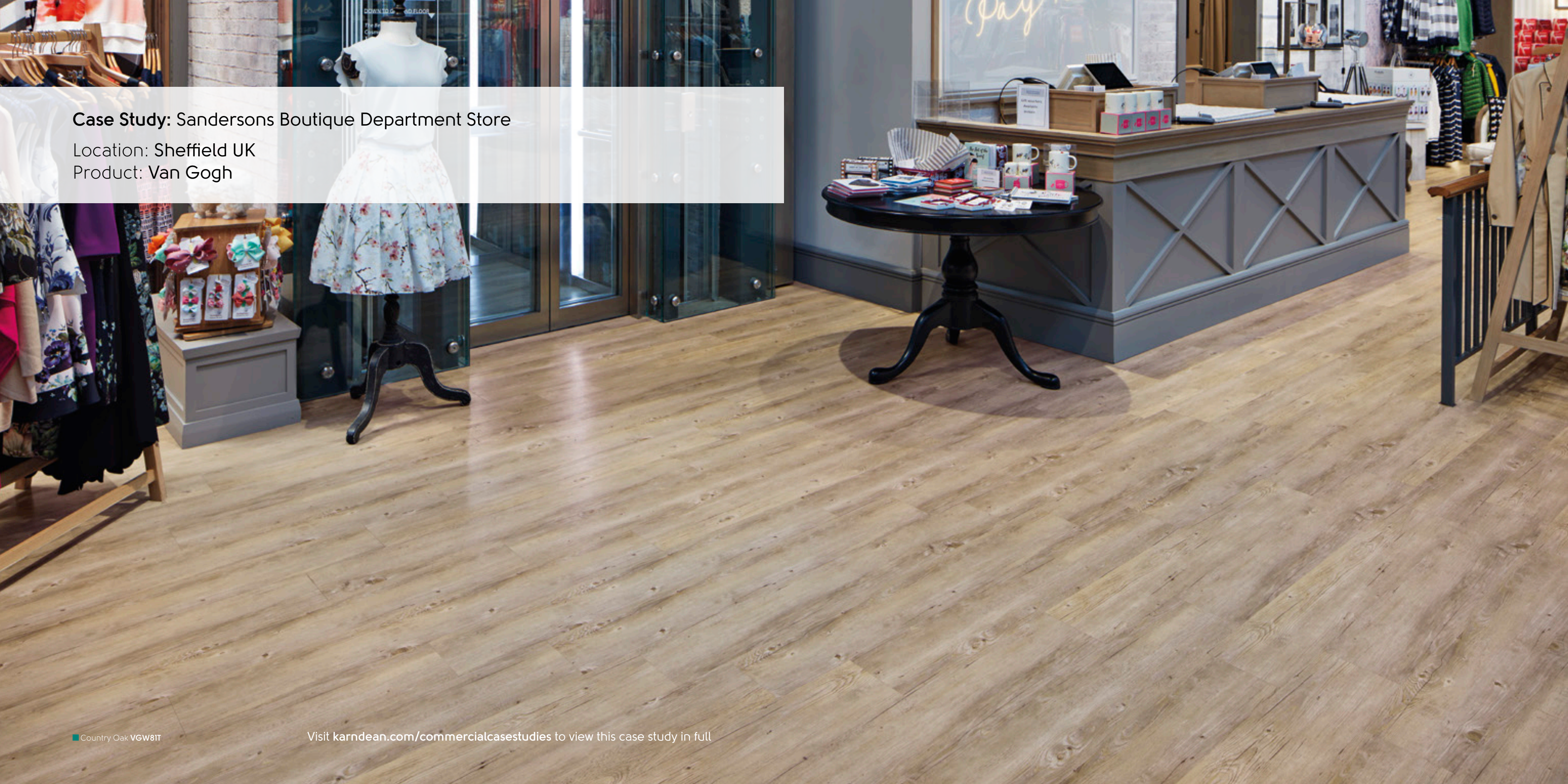

Case Study: Sandersons Boutique Department Store

Location: Sheffield UK

Product: Van Gogh



We create simply beautiful floors that will bring your vision to life.

Pale Limed Oak KP94

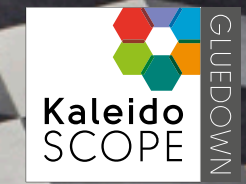

Cubes with SP111, SP213, SP114

Wood at a glance (gluedown only)

■ Art Select | ■ Van Gogh | ■ Opus | ■ Knight Tile

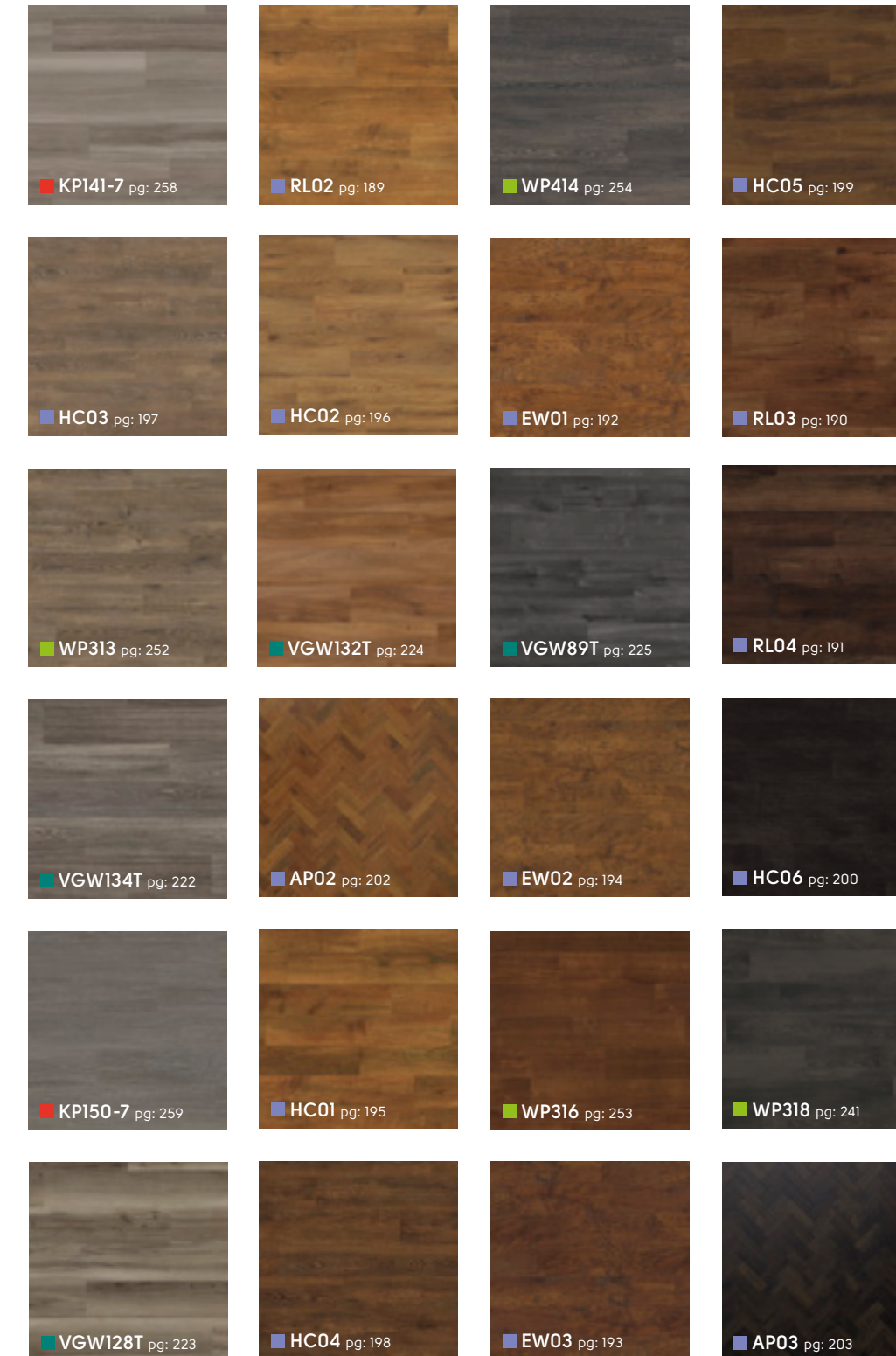
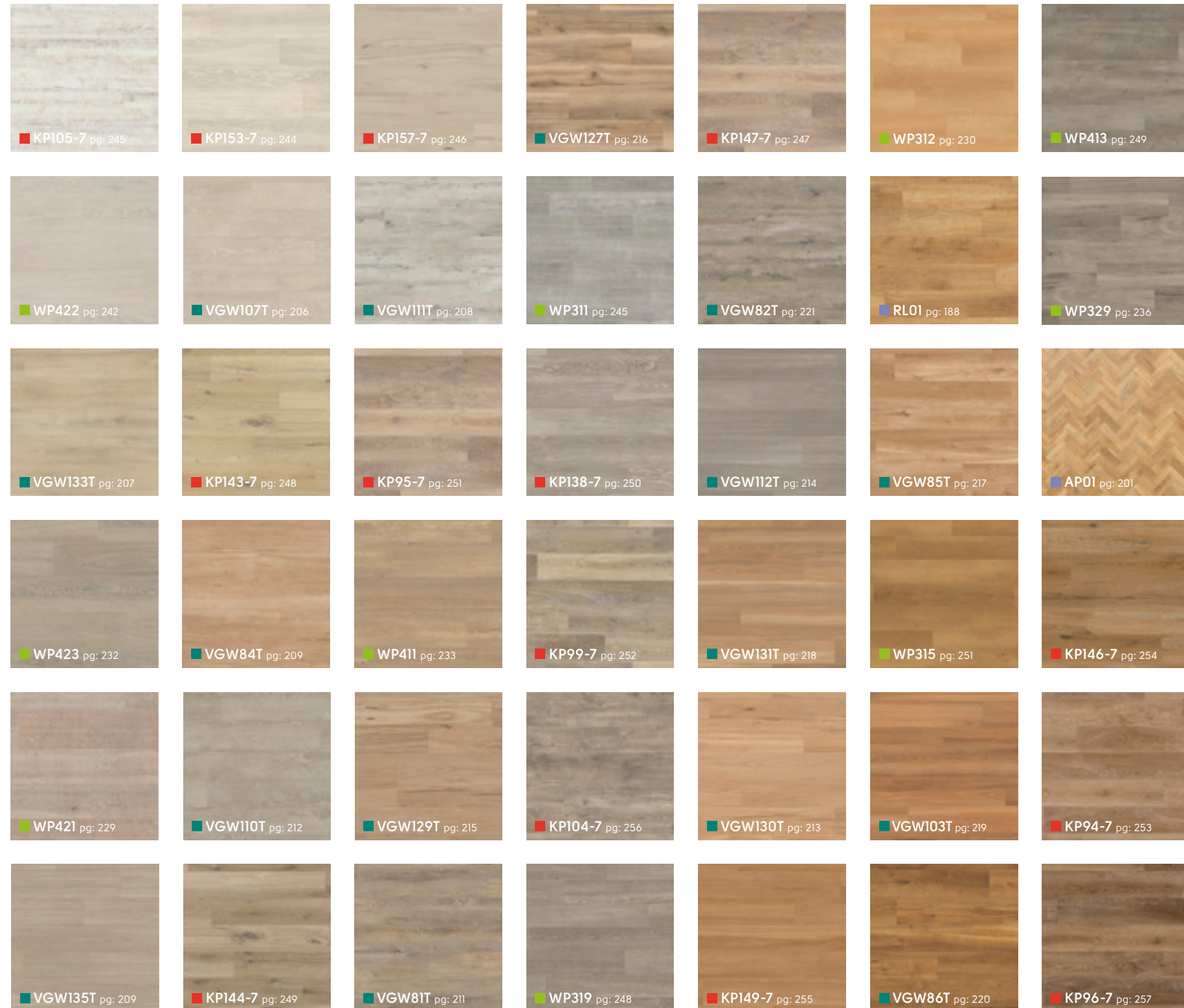

Stone at a glance (gluedown only)

■ Opus | ■ Knight Tile



Laying patterns

Karndean Designflooring products are very versatile and are designed to accommodate the growing desire for zoning individual spaces and matching 'room to room' designs. With Karndean it is possible to specify stone and wood products side by side, lay the flooring at different angles, or use different formats of the same product to create more interest.



Combining plank and parquet

Combining the plank and parquet designs allows you to differentiate areas with the same colour floor and carry the design from room to room.

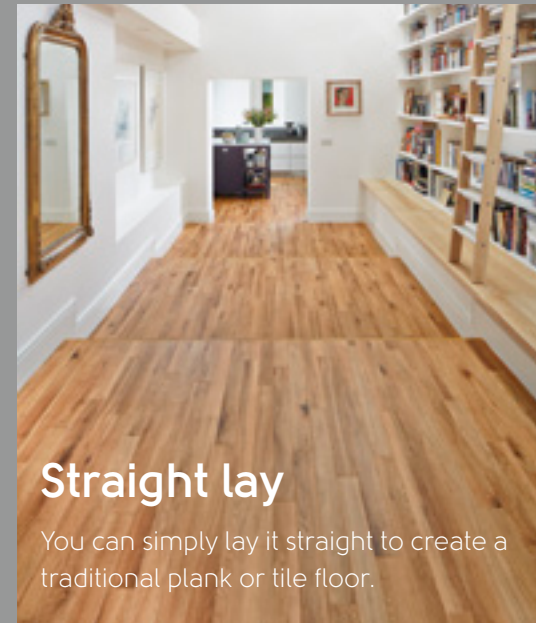

Straight lay

You can simply lay it straight to create a traditional plank or tile floor.

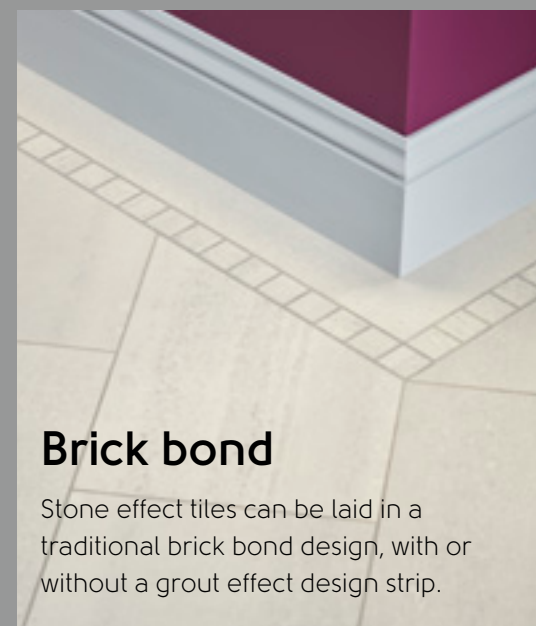

Brick bond

Stone effect tiles can be laid in a traditional brick bond design, with or without a grout effect design strip.

Herringbone

Try laying large planks or tiles in a herringbone style for a dramatic effect or alternatively for a more traditional look go for small size planks or parquet.

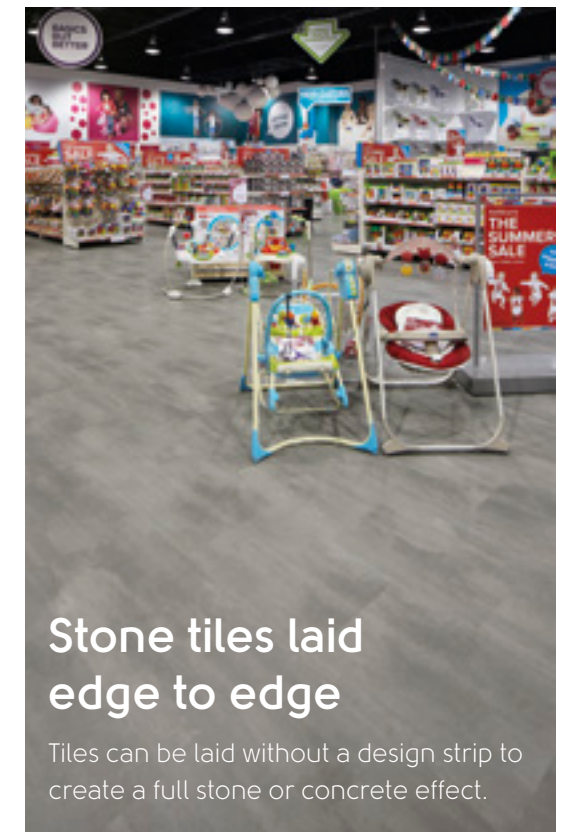
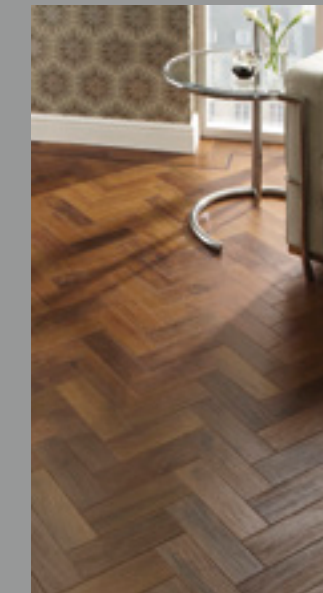
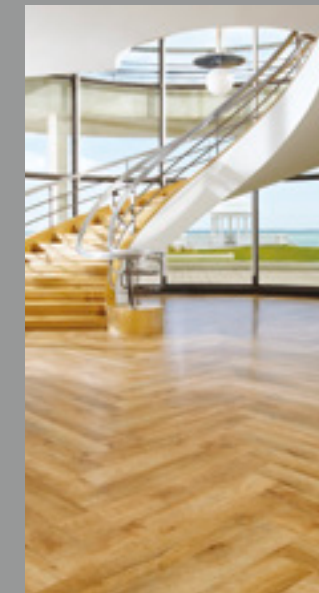

Stone tiles laid edge to edge

Tiles can be laid without a design strip to create a full stone or concrete effect.

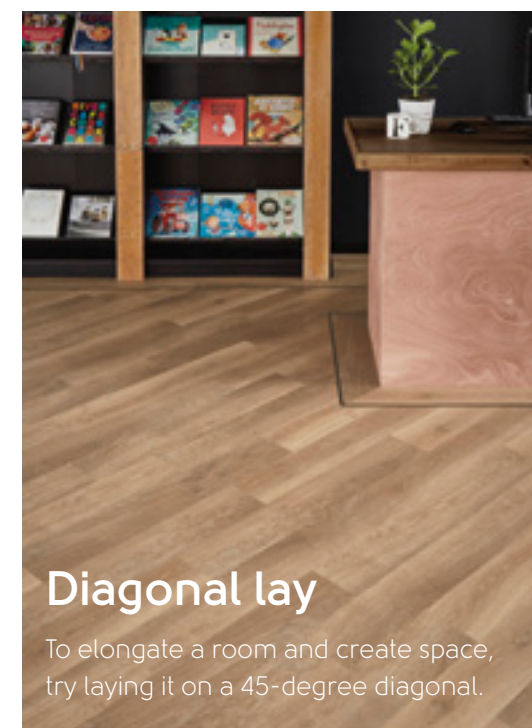

Diagonal lay

To elongate a room and create space, try laying it on a 45-degree diagonal.

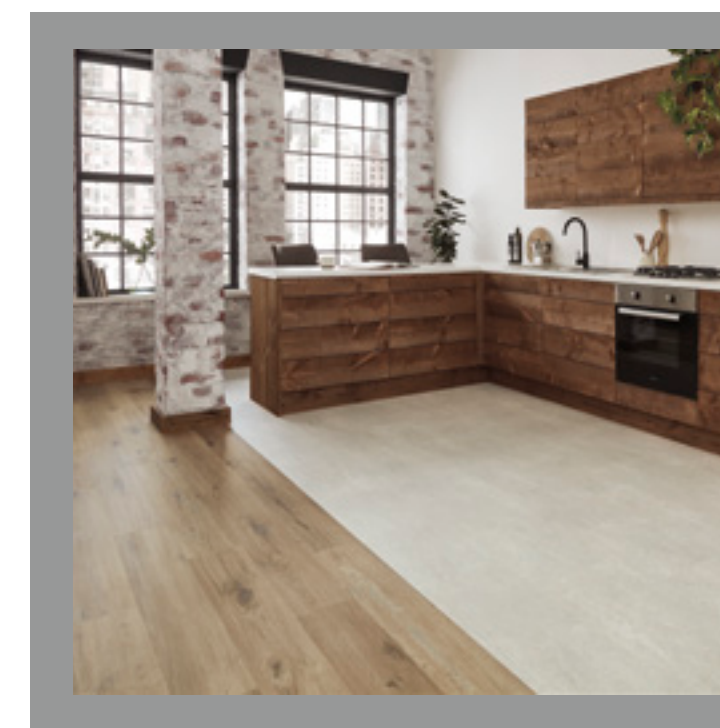

Mixing wood and stone designs

Specifying Karndean in a project allows you to easily mix wood and stone effect designs. Unlike the natural products, there is no issues of movement or lips forming when you place stone and wood effect designs next to each other.

Pattern guide

It's not just the floor you lay, but how you lay it that makes a lasting impression. We offer numerous pattern possibilities to make the most of your space. Add design strips and borders for a truly unique look.



Wood layouts

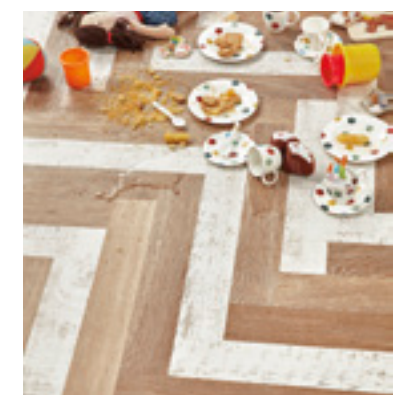

Staggered straight



Herringbone



Ship lap

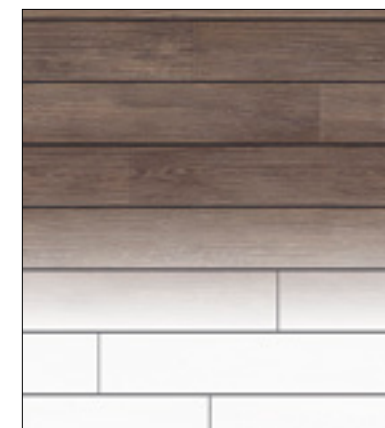

Chevron



Striped diagonal

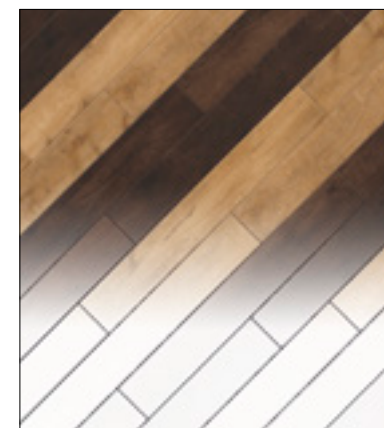

Broken herringbone



Basket weave



Bring your pattern ideas to life using our Digital Specification Library (www.karndean.com/digitalspecificationlibrary) or contact your Commercial Business Manager for more information on incorporating these designs into a future project.

Stone layouts



Brick lay



45° diagonal

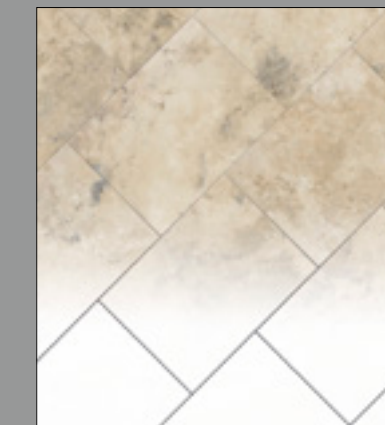

Diamond

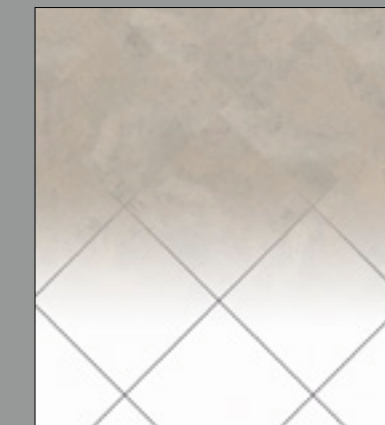

Herringbone



Striped diagonal

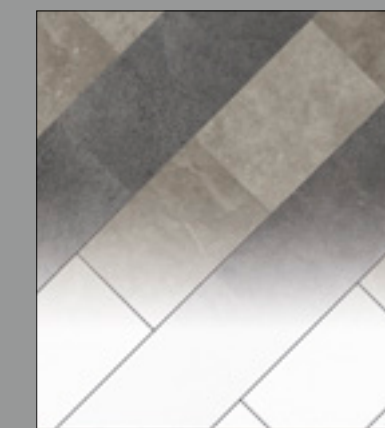

Pinwheel



Mixed wood & stone layouts

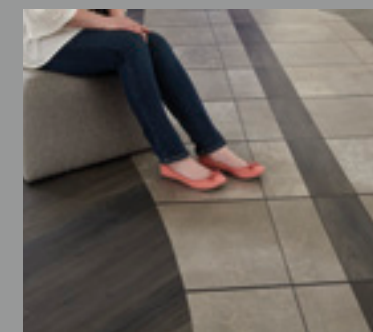

Plaid

























Alternating



Striped



Technical overview (gluedown only)

	Standard	Art Select (see page 186)			Van Gogh (see page 205)		Opus (see page 226 and 227)		Knight Tile (see page 242 and 243)			
 Size	ISO 24342	228.6 mm x 76.2 mm 914.4 mm x 152.4 mm 1219.2 mm x 177.8 mm			1219.2 mm x 177.8 mm		457.2 mm x 457.2 mm 914.4 mm x 152.4 mm 914.4 mm x 101.6 mm		609.6 mm x 457.2 mm 1219.2 mm x 228.6 mm		1219.2 mm x 177.8 mm 304.8 mm x 457.2 mm	
 Thickness	ISO 24346	3.0 mm			3.0 mm		2.5 mm		2.5 mm		2.0 mm	
 Wear layer	ISO 24340	0.7 mm			0.5 mm		0.5 mm		0.5 mm		0.3 mm	
Surface treatment		K-Guard+ PU coating			K-Guard+ PU coating		K-Guard+ PU coating		K-Guard+ PU coating		K-Guard+ PU coating	
Warranty	Commercial Domestic	20 year wear* Lifetime wear*			15 year wear* Lifetime wear*		15 year wear* Lifetime wear*		15 year wear* Lifetime wear*		10 year light commercial wear* Lifetime wear*	
 Bevelled edge		Standard			Micro		Micro		Micro		No	
 Standards	EN 649/EN ISO 10582 ASTM F1700	Pass Pass			Pass		Pass		Pass		Pass Pass	
 Classification		Commercial very heavy duty use Domestic extra heavy duty use			Commercial heavy duty use Domestic extra heavy duty use		Commercial heavy duty use Domestic extra heavy duty use		Commercial heavy duty use Domestic extra heavy duty use		Commercial light duty use Domestic heavy duty use	
 Reaction to fire	AS/NZS 9239.1:2003	Oak Royale Handcrafted Oak Premier Parquet CRF: 6.4 kW/m ² 7.1 kW/m ² 8.5 kW/m ² 8.5 kW/m ² Smoke value: 114% min 121% min 177% min 220% min			CRF: 7.3 kW/m ² Smoke value: 124% min		CRF: >11 kW/m ² Smoke value: 93% min		CRF: 8.1 kW/m ² Smoke value: 42% min			
 Staining resistance	EN ISO 26987/EN 423 ASTM F925	Excellent Pass			Excellent Pass		Excellent Pass		Excellent Pass		Excellent Pass	
 Colour fastness to light	ISO 105-B02 ASTM F1515	≥6 <8			≥7 <8		≥7 <8		≥7 <8		Pass (≥ 6) Pass (< 8)	
 Abrasion resistance	EN 660-2 ISO 10582 ASTM D3884	Group T Type I Pass			Group T Type I Pass		Group T Type I Pass		Group T Type I Pass		Group T Type I Pass	
 Flexibility	ISO 24344	Pass			Pass		Pass		Pass		Pass	
 Dimensional stability	EN 434/ISO 23999 ASTM F2199	≤0.25% Pass			≤0.25% Pass		≤0.25% Pass		≤0.25% Pass		Pass (≤ 0.25%) Pass	
 Acoustic impact noise reduction	EN ISO 717-2/ EN ISO 140-8	ΔL _w = 2 dB**			ΔL _w = 4 dB**		ΔL _w = 2 dB**		ΔL _w = 1 dB**			
 Electrical behaviour body voltage	EN 1815	Pass			Pass		Pass		Pass		Pass	
 Indentation - residual	EN 433/ISO 24343-1 ASTM F1914	≤0.1 mm <8%			≤0.1 mm <8%		≤0.1 mm <8%		≤0.1 mm <8%		Pass (≤ 0.1 mm) Pass (< 8%)	
 Castor chair continuous use	EN 425/ISO 4918	Pass			Pass		Pass		Pass		Pass	
 Thermal resistance	ISO 8302	0.0147 m ² K/W. Suitable for underfloor heating.			0.0147 m ² K/W. Suitable for underfloor heating.		0.0120 m ² K/W. Suitable for underfloor heating.		0.0120 m ² K/W. Suitable for underfloor heating.		0.0100 m ² K/W. Suitable for underfloor heating.	
 Slip resistance***	AS/NZS 4586:2013	See individual product pages			R10		R10		R10		See individual product pages	
 Adhesive	General use: High temperature:	Karndean Mega-Bond Karndean 8000 2-part Polyurethane			Karndean Mega-Bond Karndean 8000 2-part Polyurethane		Karndean Mega-Bond Karndean 8000 2-part Polyurethane		Karndean Mega-Bond Karndean 8000 2-part Polyurethane		Karndean Mega-Bond Karndean 8000 2-part Polyurethane	
 Recycling		Suitable			Suitable		Suitable		Suitable		Suitable	
 Environmental	GBCA/NZGBC GreenStar Rating System Floorscore SCS-EC10.3-2014 v4.0 Indoor Air Comfort Environmental Product Declaration NSF/ANSI 332	Indoor air quality certified; Compliant low emitting VOC emissions.			Indoor air quality certified; Compliant low emitting VOC emissions		Indoor air quality certified; Compliant low emitting VOC emissions		Indoor air quality certified; Compliant low emitting VOC emissions.		GreenTag Level 'A' + LCA Rate 'Silver Streamlined' Indoor air quality certified; Compliant low emitting VOC emissions. Gold certification Compliant low emitting VOC emissions. Product-specific Type III EPD (products with external third-party verification) Sustainability Assessment for Resilient Floor Coverings; Conformant product	
 Phthalate free		Yes			Yes		Yes		Yes		Yes	

* Subject to terms.
** Result is L_{n,w} = 58 dB when installed on Regupol 4515 acoustic underlay.
*** Slip resistance is measured on ex-factory product. Slip resistance in use will be affected by surface contamination and by how the product is maintained.



■ Bleached Grey Walnut WP329

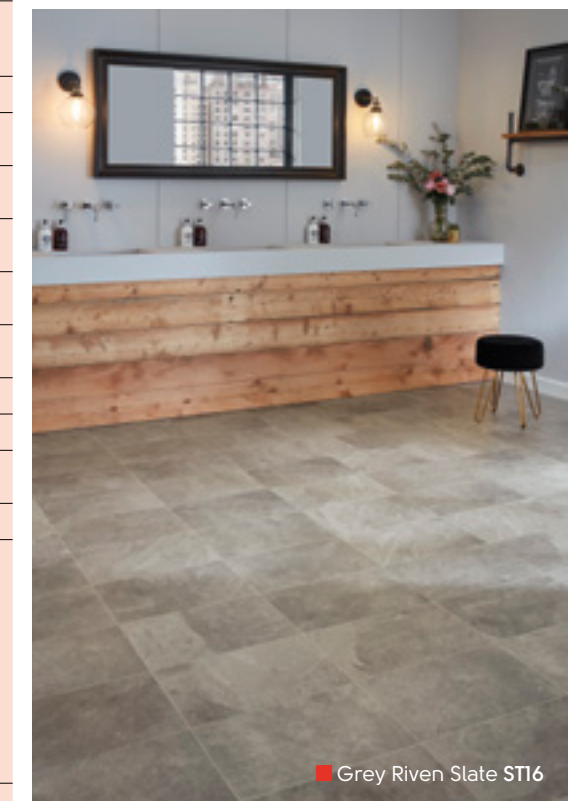

■ Grey Riven Slate ST16

Art Select Wood



Oak Royale

1219mm x 178mm (48" x 7")



Page: 188

Spring Oak **RL01***



Page: 189

Summer Oak **RL02**



Page: 190

Autumn Oak **RL03**

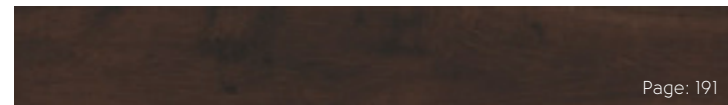

Page: 191

Winter Oak **RL04**

Oak Premier

915mm x 152mm (36" x 6")



Page: 195

Dawn Oak **HC01***



Page: 196

Morning Oak **HC02**



Page: 197

Dusk Oak **HC03**



Page: 198

Sundown Oak **HC04**

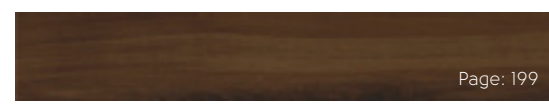

Page: 199

Evening Oak **HC05**

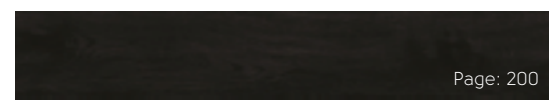

Page: 200

Midnight Oak **HC06***

Handcrafted

915mm x 152mm (36" x 6")



Page: 192

Hickory Paprika **EW01**



Page: 193

Hickory Nutmeg **EW03**



Page: 194

Hickory Peppercorn **EW02**

Parquet

228mm x 76mm (9" x 3")

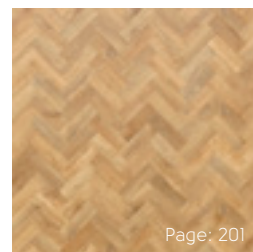

Page: 201

Blond Oak **AP01***

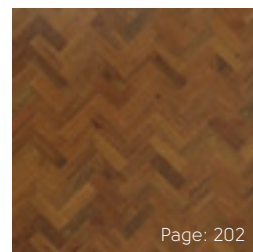

Page: 202

Auburn Oak **AP02***

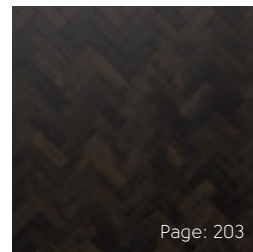

Page: 203

Black Oak **AP03***

* Same colour available in different formats, see individual product pages for details.

Art Select Wood

Through meticulous attention to detail and careful selection of some of the most beautiful and inspiring natural timbers, our Art Select wood collection includes our most intricate designs and realistic embosses. Each plank is handcrafted to reflect the unique grains, knots and textures of natural wood, but unlike real wood, we're able to design a floor that's not only beautiful and realistic, but also practical.



Autumn Oak **RL03**

	Standard	Result
Size	ISO 24342	See individual product pages
Thickness	ISO 24346	3.0 mm
Wear layer	ISO 24340	0.7 mm
Surface treatment		K-Guard+ PU coating
Warranty	Commercial Domestic	20 year wear* Lifetime wear*
Bevelled edge		Standard
Standards	EN 649/EN ISO 10582 ASTM F1700	Pass Pass
Classification		Commercial very heavy duty use Domestic extra heavy duty use
Reaction to fire	AS/NZS 9239.1:2003	Oak Royale Handcrafted Oak Premier Parquet CRF: 6.4 kW/m ² 7.1 kW/m ² 8.5 kW/m ² 8.5 kW/m ² Smoke value: 114% min 121% min 177% min 220% min
Staining resistance	EN ISO 26987/EN 423 ASTM F925	Excellent Pass
Colour fastness to light	ISO 105-B02 ASTM F1515	≥6 <8
Abrasion resistance	EN 660-2 ISO 10582 ASTM D3884	Group T Type 1 Pass
Flexibility	ISO 24344	Pass
Dimensional stability	EN 434/ISO 23999 ASTM F2199	≤0.25% Pass
Acoustic impact noise reduction	EN ISO 717-2/ EN ISO 140-8	ΔL _w = 2 dB**
Electrical behaviour body voltage	EN 1815	Pass
Indentation - residual	EN 433/ISO 24343-1 ASTM F1914	≤0.1 mm <8%
Castor chair continuous use	EN 425/ISO 4918	Pass
Thermal resistance	ISO 8302	0.0147 m ² K/W Suitable for underfloor heating.
Slip resistance***	AS/NZS 4586:2013	R9
Adhesive	General use: High temperature:	Karndean Mega-Bond Karndean 8000 2-part Polyurethane
Recycling		Suitable
Environmental	Floorscore SCS- ECl0.3-2014 v4.0	Indoor air quality certified; Compliant low emitting VOC emissions
Phthalate free		Yes

* Subject to terms. Please see our website.

** Result is L_{n,w} = 58 dB when installed on Regupol 4515 acoustic underlay.

*** Slip resistance is measured on ex-factory product. Slip resistance can be affected by surface contamination, use and how the product is maintained.

Spring Oak RL01



Summer Oak RL02



Size	1219mm x 178mm (48" x 7")
Thickness	3.0mm
Wear Layer	0.7mm
Bevel	Standard
Box Quantity	15 Planks/3.25m ²

Suitability/Application:
Commercial very heavy duty use
Domestic extra heavy duty use



Slip Resistance/Result:
Oil Wet Ramp R9

Technical Specifications:
Page: 187

This product is also available
in parquet format. See page: 201.

Size	1219mm x 178mm (48" x 7")
Thickness	3.0mm
Wear Layer	0.7mm
Bevel	Standard
Box Quantity	15 Planks/3.25m ²

Suitability/Application:
Commercial very heavy duty use
Domestic extra heavy duty use

Slip Resistance/Result:
Oil Wet Ramp R9

Technical Specifications:
Page: 187

Autumn Oak RL03



Winter Oak RL04



Size	1219mm x 178mm (48" x 7")
Thickness	3.0mm
Wear Layer	0.7mm
Bevel	Standard
Box Quantity	15 Planks/3.25m ²

Suitability/Application:
Commercial very heavy duty use
Domestic extra heavy duty use

Slip Resistance/Result:
Oil Wet Ramp R9

Technical Specifications:
Page: 187

Size	1219mm x 178mm (48" x 7")
Thickness	3.0mm
Wear Layer	0.7mm
Bevel	Standard
Box Quantity	15 Planks/3.25m ²

Suitability/Application:
Commercial very heavy duty use
Domestic extra heavy duty use

Slip Resistance/Result:
Oil Wet Ramp R9

Technical Specifications:
Page: 187

Hickory Paprika EW01



Size	915mm x 152mm (36" x 6")
Thickness	3.0mm
Wear Layer	0.7mm
Bevel	Standard
Box Quantity	24 Planks/3.34m ²

Suitability/Application:
Commercial very heavy duty use
Domestic extra heavy duty use

Slip Resistance/Result:
Oil Wet Ramp R9

Technical Specifications:
Page: 187

Hickory Nutmeg EW03



Size	915mm x 152mm (36" x 6")
Thickness	3.0mm
Wear Layer	0.7mm
Bevel	Standard
Box Quantity	24 Planks/3.34m ²

Suitability/Application:
Commercial very heavy duty use
Domestic extra heavy duty use

Slip Resistance/Result:
Oil Wet Ramp R9

Technical Specifications:
Page: 187

Hickory Peppercorn EW02



Size	915mm x 152mm (36" x 6")
Thickness	3.0mm
Wear Layer	0.7mm
Bevel	Standard
Box Quantity	24 Planks/3.34m ²

Suitability/Application:
Commercial very heavy duty use
Domestic extra heavy duty use

Slip Resistance/Result:
Oil Wet Ramp R9

Technical Specifications:
Page: 187

Dawn Oak HC01



Size	915mm x 152mm (36" x 6")
Thickness	3.0mm
Wear Layer	0.7mm
Bevel	Standard
Box Quantity	24 Planks/3.34m ²

Suitability/Application:
Commercial very heavy duty use
Domestic extra heavy duty use

Slip Resistance/Result:
Oil Wet Ramp R9

Technical Specifications:
Page: 187

This product is also available
in parquet format. See page: 202.

Morning Oak HC02



Dusk Oak HC03



Size	915mm x 152mm (36" x 6")
Thickness	3.0mm
Wear Layer	0.7mm
Bevel	Standard
Box Quantity	24 Planks/3.34m ²

Suitability/Application:
Commercial very heavy duty use
Domestic extra heavy duty use

Slip Resistance/Result:
Oil Wet Ramp R9

Technical Specifications:
Page: 187

Size	915mm x 152mm (36" x 6")
Thickness	3.0mm
Wear Layer	0.7mm
Bevel	Standard
Box Quantity	24 Planks/3.34m ²

Suitability/Application:
Commercial very heavy duty use
Domestic extra heavy duty use

Slip Resistance/Result:
Oil Wet Ramp R9

Technical Specifications:
Page: 187



Sundown Oak HC04



Size	915mm x 152mm (36" x 6")
Thickness	3.0mm
Wear Layer	0.7mm
Bevel	Standard
Box Quantity	24 Planks/3.34m ²

Suitability/Application:
Commercial very heavy duty use
Domestic extra heavy duty use

Slip Resistance/Result:
Oil Wet Ramp R9

Technical Specifications:
Page: 187

Evening Oak HC05



Size	915mm x 152mm (36" x 6")
Thickness	3.0mm
Wear Layer	0.7mm
Bevel	Standard
Box Quantity	24 Planks/3.34m ²

Suitability/Application:
Commercial very heavy duty use
Domestic extra heavy duty use

Slip Resistance/Result:
Oil Wet Ramp R9

Technical Specifications:
Page: 187

Midnight Oak HC06



Blond Oak AP01



Size	915mm x 152mm (36" x 6")
Thickness	3.0mm
Wear Layer	0.7mm
Bevel	Standard
Box Quantity	24 Planks/3.34m ²

Suitability/Application:
Commercial very heavy duty use
Domestic extra heavy duty use



Slip Resistance/Result:
Oil Wet Ramp R9

Technical Specifications:
Page: 187

This product is also available
in parquet format. See page: 203.

Size	228mm x 76mm (9" x 3")
Thickness	3.0mm
Wear Layer	0.7mm
Bevel	Standard
Box Quantity	192 Planks/3.34m ²

Suitability/Application:
Commercial very heavy duty use
Domestic extra heavy duty use

Slip Resistance/Result:
Oil Wet Ramp R9

Technical Specifications:
Page: 187

This product is also available
in plank format. See page: 188.

Auburn Oak AP02



Size	228mm x 76mm (9" x 3")
Thickness	3.0mm
Wear Layer	0.7mm
Bevel	Standard
Box Quantity	192 Planks/3.34m ²

Suitability/Application:
Commercial very heavy duty use
Domestic extra heavy duty use

Slip Resistance/Result:
Oil Wet Ramp R9

Technical Specifications:
Page: 187

This product is also available
in plank format. See page: 195.

Black Oak AP03



Size	228mm x 76mm (9" x 3")
Thickness	3.0mm
Wear Layer	0.7mm
Bevel	Standard
Box Quantity	192 Planks/3.34m ²

Suitability/Application:
Commercial very heavy duty use
Domestic extra heavy duty use

Slip Resistance/Result:
Oil Wet Ramp R9

















Technical Specifications:
Page: 187

This product is also available
in plank format. See page: 200.

Van Gogh Wood

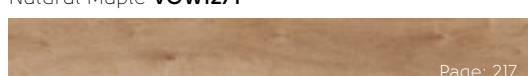

1219mm x 178mm (48" x 7")

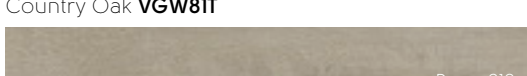
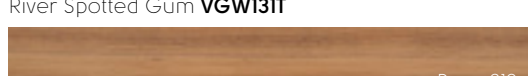























 Blush Oak VGW107T Page: 206	 Eastern Blackbutt VGW130T Page: 213	 Classic Oak VGW86T Page: 220
 Millstone Sycamore VGW133T Page: 207	 Misty Grey Oak VGW112T Page: 214	 Distressed Oak VGW82T Page: 221
 Light Distressed Oak VGW111T Page: 208	 Washed Blackbutt VGW129T Page: 215	 Nocturne Oak VGW134T Page: 222
 Tranquil Oak VGW135T Page: 209	 Natural Maple VGW127T Page: 216	 Smoked Maple VGW128T Page: 223
 Birch VGW84T Page: 210	 French Oak VGW85T Page: 217	 Marron Elm VGW132T Page: 224
 Country Oak VGW81T Page: 211	 River Spotted Gum VGW131T Page: 218	 Ebony VGW89T Page: 225
 Greige Oak VGW110T Page: 212	 Northern Spotted Gum VGW103T Page: 219	

* Please note: as a feature of the design, these products incorporate a high colour variation between individual planks.

Van Gogh Wood

Our collection of Van Gogh woods captures the look and feel of real timber in a variety of colour and designs from traditional rustic to cool contemporary. These large planks, distinctive grain details and subtle texture creates a style that works in both residential and commercial environments. The colour range in the Van Gogh collection offers a broad variety. From the pale tones of Blush oak to the striking dark tones of Ebony, it adds style to any space.



	Standard	Result
 Size	ISO 24342	1219 mm x 178 mm (48" x 7")
 Thickness	ISO 24346	3.0 mm
 Wear layer		0.5 mm
 Surface treatment		K-Guard+ PU coating
 Warranty	Commercial Domestic	15 year wear* Lifetime wear*
 Bevelled edge		Micro
 Standards	ASTM F1700	Pass
 Classification		Commercial heavy duty use Domestic extra heavy duty use
 Reaction to fire	AS/NZS 9239.1:2010	CRF: 7.3 kW/m ² Smoke value: 124% min
 Staining resistance	EN ISO 26987/EN 423 ASTM F925	Excellent Pass
 Colour fastness to light	ISO 105-B02 ASTM F1515	≥7 <8
 Abrasion resistance	EN 660-2 ISO 10582 ASTM D3884	Group T Type 1 Pass
 Flexibility	ISO 24344	Pass
 Dimensional stability	EN 434/ISO 23999 ASTM F2199	≤0.25% Pass
 Acoustic impact noise reduction	EN ISO 717-2/ EN ISO 140-8	ΔL _w = 4 dB**
 Electrical behaviour body voltage	EN 1815	Pass
 Indentation - residual	EN 433/ISO 24343-1 ASTM F1914	≤0.1 mm <8%
 Castor chair continuous use	EN 425	Pass
 Thermal resistance	ISO 8302	0.0147 m ² K/W Suitable for underfloor heating.
 Slip resistance***	AS/NZS 4586:2013	R10
 Adhesive	General use: High temperature:	Karndean Mega-Bond Karndean 8000 2-part Polyurethane
 Recycling		Suitable
 Environmental	Floorscore SCS- EC10.3-2014 v4.0	Indoor air quality certified. Compliant low emitting VOC emissions
 Phthalate free		Yes

* Subject to terms. Please see our website.
 ** Result is Ln,w = 58 dB when installed on Regupol 4515 acoustic underlay.
 *** Slip resistance is measured on ex-factory product. Slip resistance can be affected by surface contamination, use and how the product is maintained.

Blush Oak VGW107T



Size	1219mm x 178mm (48" x 7")
Thickness	3.0mm
Wear Layer	0.5mm
Bevel	Micro
Box Quantity	15 Planks/3.25m ²

Suitability/Application:
Commercial heavy duty use
Domestic extra heavy duty use

Slip Resistance/Result:
Oil Wet Ramp R10

Technical Specifications:
Page: 205

Millstone Sycamore VGW133T



Size	1219mm x 178mm (48" x 7")
Thickness	3.0mm
Wear Layer	0.5mm
Bevel	Micro
Box Quantity	15 Planks/3.25m ²

Suitability/Application:
Commercial heavy duty use
Domestic extra heavy duty use

Slip Resistance/Result:
Oil Wet Ramp R10

Technical Specifications:
Page: 205

Light Distressed Oak VGW111T



Tranquil Oak VGW135T



Size	1219mm x 178mm (48" x 7")
Thickness	3.0mm
Wear Layer	0.5mm
Bevel	Micro
Box Quantity	15 Planks/3.25m ²

Suitability/Application:
Commercial heavy duty use
Domestic extra heavy duty use

Slip Resistance/Result:
Oil Wet Ramp R10

Technical Specifications:
Page: 205

Size	1219mm x 178mm (48" x 7")
Thickness	3.0mm
Wear Layer	0.5mm
Bevel	Micro
Box Quantity	15 Planks/3.25m ²

Suitability/Application:
Commercial heavy duty use
Domestic extra heavy duty use

Slip Resistance/Result:
Oil Wet Ramp R10

Technical Specifications:
Page: 205

Birch VGW84T



Country Oak VGW81T



Size	1219mm x 178mm (48" x 7")
Thickness	3.0mm
Wear Layer	0.5mm
Bevel	Micro
Box Quantity	15 Planks/3.25m ²

Suitability/Application:
Commercial heavy duty use
Domestic extra heavy duty use

Slip Resistance/Result:
Oil Wet Ramp R10

Technical Specifications:
Page: 205

Size	1219mm x 178mm (48" x 7")
Thickness	3.0mm
Wear Layer	0.5mm
Bevel	Micro
Box Quantity	15 Planks/3.25m ²

Suitability/Application:
Commercial heavy duty use
Domestic extra heavy duty use

Slip Resistance/Result:
Oil Wet Ramp R10

Technical Specifications:
Page: 205

Greige Oak VGW110T



Size	1219mm x 178mm (48" x 7")
Thickness	3.0mm
Wear Layer	0.5mm
Bevel	Micro
Box Quantity	15 Planks/3.25m ²

Suitability/Application:
Commercial heavy duty use
Domestic extra heavy duty use

Slip Resistance/Result:
Oil Wet Ramp R10

Technical Specifications:
Page: 205

Eastern Blackbutt VGW130T



Size	1219mm x 178mm (48" x 7")
Thickness	3.0mm
Wear Layer	0.5mm
Bevel	Micro
Box Quantity	15 Planks/3.25m ²

Suitability/Application:
Commercial heavy duty use
Domestic extra heavy duty use

Slip Resistance/Result:
Oil Wet Ramp R10

Technical Specifications:
Page: 205

Misty Grey Oak VGW112T



Washed Blackbutt VGW129T



Size	1219mm x 178mm (48" x 7")
Thickness	3.0mm
Wear Layer	0.5mm
Bevel	Micro
Box Quantity	15 Planks/3.25m ²

Suitability/Application:
Commercial heavy duty use
Domestic extra heavy duty use

Slip Resistance/Result:
Oil Wet Ramp R10

Technical Specifications:
Page: 205

Size	1219mm x 178mm (48" x 7")
Thickness	3.0mm
Wear Layer	0.5mm
Bevel	Micro
Box Quantity	15 Planks/3.25m ²

Suitability/Application:
Commercial heavy duty use
Domestic extra heavy duty use

Slip Resistance/Result:
Oil Wet Ramp R10

Technical Specifications:
Page: 205

Natural Maple VGW127T



Size	1219mm x 178mm (48" x 7")
Thickness	3.0mm
Wear Layer	0.5mm
Bevel	Micro
Box Quantity	15 Planks/3.25m ²

Suitability/Application:
Commercial heavy duty use
Domestic extra heavy duty use

Slip Resistance/Result:
Oil Wet Ramp R10

Technical Specifications:
Page: 205

French Oak VGW85T



Size	1219mm x 178mm (48" x 7")
Thickness	3.0mm
Wear Layer	0.5mm
Bevel	Micro
Box Quantity	15 Planks/3.25m ²

Suitability/Application:
Commercial heavy duty use
Domestic extra heavy duty use

Slip Resistance/Result:
Oil Wet Ramp R10

Technical Specifications:
Page: 205

River Spotted Gum VGW131T



Size	1219mm x 178mm (48" x 7")
Thickness	3.0mm
Wear Layer	0.5mm
Bevel	Micro
Box Quantity	15 Planks/3.25m ²

Suitability/Application:
Commercial heavy duty use
Domestic extra heavy duty use

Slip Resistance/Result:
Oil Wet Ramp R10

Technical Specifications:
Page: 205

Northern Spotted Gum VGW103T



Size	1219mm x 178mm (48" x 7")
Thickness	3.0mm
Wear Layer	0.5mm
Bevel	Micro
Box Quantity	15 Planks/3.25m ²

Suitability/Application:
Commercial heavy duty use
Domestic extra heavy duty use

Slip Resistance/Result:
Oil Wet Ramp R10

Technical Specifications:
Page: 205

Classic Oak VGW86T



Distressed Oak VGW82T



Size	1219mm x 178mm (48" x 7")
Thickness	3.0mm
Wear Layer	0.5mm
Bevel	Micro
Box Quantity	15 Planks/3.25m ²

Suitability/Application:
Commercial heavy duty use
Domestic extra heavy duty use

Slip Resistance/Result:
Oil Wet Ramp R10

Technical Specifications:
Page: 205

Size	1219mm x 178mm (48" x 7")
Thickness	3.0mm
Wear Layer	0.5mm
Bevel	Micro
Box Quantity	15 Planks/3.25m ²

Suitability/Application:
Commercial heavy duty use
Domestic extra heavy duty use

Slip Resistance/Result:
Oil Wet Ramp R10

Technical Specifications:
Page: 205

Nocturne Oak VGW134T



Smoked Maple VGW128T



Size	1219mm x 178mm (48" x 7")
Thickness	3.0mm
Wear Layer	0.5mm
Bevel	Micro
Box Quantity	15 Planks/3.25m ²

Suitability/Application:
Commercial heavy duty use
Domestic extra heavy duty use

Slip Resistance/Result:
Oil Wet Ramp R10

Technical Specifications:
Page: 205

Size	1219mm x 178mm (48" x 7")
Thickness	3.0mm
Wear Layer	0.5mm
Bevel	Micro
Box Quantity	15 Planks/3.25m ²

Suitability/Application:
Commercial heavy duty use
Domestic extra heavy duty use

Slip Resistance/Result:
Oil Wet Ramp R10

Technical Specifications:
Page: 205

Marron Elm VGW132T



Ebony VGW89T



Size	1219mm x 178mm (48" x 7")
Thickness	3.0mm
Wear Layer	0.5mm
Bevel	Micro
Box Quantity	15 Planks/3.25m ²

Suitability/Application:
Commercial heavy duty use
Domestic extra heavy duty use

Slip Resistance/Result:
Oil Wet Ramp R10

Technical Specifications:
Page: 205

Size	1219mm x 178mm (48" x 7")
Thickness	3.0mm
Wear Layer	0.5mm
Bevel	Micro
Box Quantity	15 Planks/3.25m ²

Suitability/Application:
Commercial heavy duty use
Domestic extra heavy duty use

Slip Resistance/Result:
Oil Wet Ramp R10

Technical Specifications:
Page: 205

Opus Wood



1219mm x 228mm (48" x 9")



Columba **WP422**



Niveus **WP411**

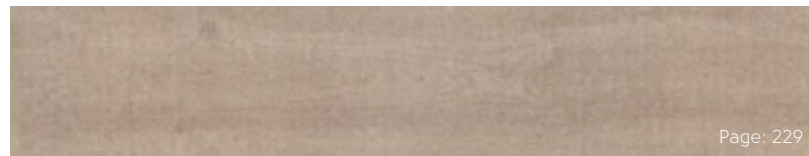

Rubesco **WP421**

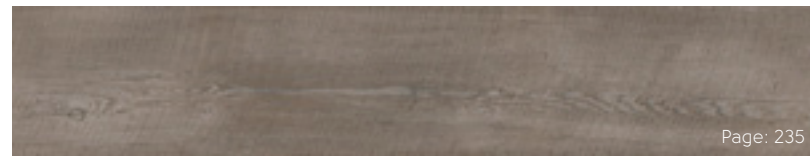

Magna **WP413**



Avena **WP423**



Argen **WP414**

915mm x 152mm (36" x 6")



Grano **WP311**

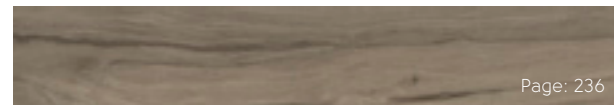

Bleached Grey Walnut **WP329**



Talpa **WP319**



Ignea **WP313**



Palleo **WP312**



Rubra **WP316**

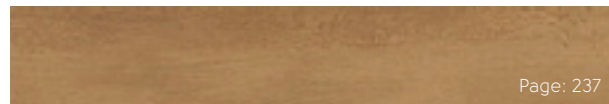

Aurum **WP315**

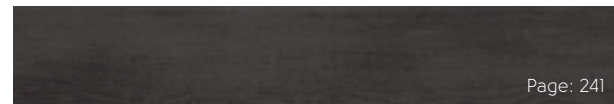

Carbo **WP318**

Opus Wood

Our Opus collection brings you a fresh, modern feel in some of our largest plank sizes. The wide range of tones and mix of surface finishes, combined with clean lines, means you can achieve a sense of simplicity and visual space, whatever your colour scheme. The collection's 915mm x 152mm planks offer a wide range of colours from the light tones of Niveus to the dark brown hues of Rubra. The collection also offers large scale 1219mm x 228mm planks available in six distinctive colours. The pale colours of Niveus provide a modern and neutral backdrop, while the bold colours of Rubra features warmer, golden tones.



	Standard	Result
Size	ISO 24342	See individual product pages
Thickness	ISO 24346	2.5 mm
Wear layer		0.5 mm
Surface treatment		K-Guard+ PU coating
Warranty	Commercial Domestic	15 year wear* Lifetime wear*
Bevelled edge		Micro
Standards	ASTM F1700	Pass
Classification		Commercial heavy duty use Domestic extra heavy duty use
Reaction to fire	AS/NZS 9239.1:2010	CRF: >11 kW/m ² Smoke value: 93% min
Staining resistance	EN ISO 26987/EN 423 ASTM F925	Excellent Pass
Colour fastness to light	ISO 105-B02 ASTM F1515	≥7 <8
Abrasion resistance	EN 660-2 ISO 10582 ASTM D3884	Group T Type 1 Pass
Flexibility	ISO 24344	Pass
Dimensional stability	EN 434/ISO 23999 ASTM F2199	≤0.25% Pass
Acoustic impact noise reduction	EN ISO 717-2/ EN ISO 140-8	ΔL _w = 2 dB**
Electrical behaviour body voltage	EN 1815	Pass
Indentation - residual	EN 433/ISO 24343-1 ASTM F1914	≤0.1 mm <8%
Castor chair continuous use	EN 425/ISO 4918	Pass
Thermal resistance	ISO 8302	0.0120 m ² K/W Suitable for underfloor heating.
Slip resistance***	AS/NZS 4586:2013	R10
Adhesive	General use: High temperature:	Karndean Mega-Bond Karndean 8000 2-part Polyurethane
Recycling		Suitable
Environmental	Floorscore SCS- EC10.3-2014 v4.0	Indoor air quality certified: Compliant low emitting VOC emissions.
Phthalate free		Yes

* Subject to terms. Please see our website.

** Result is Ln,w = 58 dB when installed on Regupol 4515 acoustic underlay.

*** Slip resistance is measured on ex-factory product. Slip resistance can be affected by surface contamination, use and how the product is maintained.

Columba WP422



Rubesco WP421



Size	1219mm x 228mm (48" x 9")
Thickness	2.5mm
Wear Layer	0.5mm
Bevel	Micro
Box Quantity	12 Planks/3.34m ²

Suitability/Application:
Commercial heavy duty use
Domestic extra heavy duty use

Slip Resistance/Result:
Oil Wet Ramp R10

Technical Specifications:
Page: 227

Size	1219mm x 228mm (48" x 9")
Thickness	2.5mm
Wear Layer	0.5mm
Bevel	Micro
Box Quantity	12 Planks/3.34m ²

Suitability/Application:
Commercial heavy duty use
Domestic extra heavy duty use

Slip Resistance/Result:
Oil Wet Ramp R10

Technical Specifications:
Page: 227

Palleo WP312



Size	915mm x 152mm (36" x 6")
Thickness	2.5mm
Wear Layer	0.5mm
Bevel	Micro
Box Quantity	24 Planks/3.34m ²

Suitability/Application:
Commercial heavy duty use
Domestic extra heavy duty use

Slip Resistance/Result:
Oil Wet Ramp R10

Technical Specifications:
Page: 227

Grano WP311



Size	915mm x 152mm (36" x 6")
Thickness	2.5mm
Wear Layer	0.5mm
Bevel	Micro
Box Quantity	24 Planks/3.34m ²

Suitability/Application:
Commercial heavy duty use
Domestic extra heavy duty use

Slip Resistance/Result:
Oil Wet Ramp R10

Technical Specifications:
Page: 227

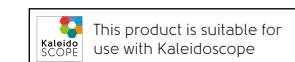

Avena WP423



Niveus WP411



Size	1219mm x 228mm (48" x 9")
Thickness	2.5mm
Wear Layer	0.5mm
Bevel	Micro
Box Quantity	12 Planks/3.34m ²

Suitability/Application:
Commercial heavy duty use
Domestic extra heavy duty use

Slip Resistance/Result:
Oil Wet Ramp R10

Technical Specifications:
Page: 227

Size	1219mm x 228mm (48" x 9")
Thickness	2.5mm
Wear Layer	0.5mm
Bevel	Micro
Box Quantity	12 Planks/3.34m ²

Suitability/Application:
Commercial heavy duty use
Domestic extra heavy duty use

Slip Resistance/Result:
Oil Wet Ramp R10

Technical Specifications:
Page: 227

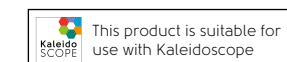

Talpa WP319



Magna WP413



Size	915mm x 152mm (36" x 6")
Thickness	2.5mm
Wear Layer	0.5mm
Bevel	Micro
Box Quantity	24 Planks/3.34m ²

Suitability/Application:
Commercial heavy duty use
Domestic extra heavy duty use

Slip Resistance/Result:
Oil Wet Ramp R10

Technical Specifications:
Page: 227

Size	1219mm x 228mm (48" x 9")
Thickness	2.5mm
Wear Layer	0.5mm
Bevel	Micro
Box Quantity	12 Planks/3.34m ²

Suitability/Application:
Commercial heavy duty use
Domestic extra heavy duty use

Slip Resistance/Result:
Oil Wet Ramp R10

Technical Specifications:
Page: 227

Bleached Grey Walnut WP329



Size	915mm x 152mm (36" x 6")
Thickness	2.5mm
Wear Layer	0.5mm
Bevel	Micro
Box Quantity	24 Planks/3.34m ²

Suitability/Application:
Commercial heavy duty use
Domestic extra heavy duty use

Slip Resistance/Result:
Oil Wet Ramp R10

Technical Specifications:
Page: 227

Aurum WP315



Size	915mm x 152mm (36" x 6")
Thickness	2.5mm
Wear Layer	0.5mm
Bevel	Micro
Box Quantity	24 Planks/3.34m ²

Suitability/Application:
Commercial heavy duty use
Domestic extra heavy duty use

Slip Resistance/Result:
Oil Wet Ramp R10

Technical Specifications:
Page: 227

Ignea WP313



Rubra WP316



Size	915mm x 152mm (36" x 6")
Thickness	2.5mm
Wear Layer	0.5mm
Bevel	Micro
Box Quantity	24 Planks/3.34m ²

Suitability/Application:
Commercial heavy duty use
Domestic extra heavy duty use



Slip Resistance/Result:
Oil Wet Ramp R10

Technical Specifications:
Page: 227

Size	915mm x 152mm (36" x 6")
Thickness	2.5mm
Wear Layer	0.5mm
Bevel	Micro
Box Quantity	24 Planks/3.34m ²

Suitability/Application:
Commercial heavy duty use
Domestic extra heavy duty use

Slip Resistance/Result:
Oil Wet Ramp R10

Technical Specifications:
Page: 227

Argen WP414



Size	1219mm x 228mm (48" x 9")
Thickness	2.5mm
Wear Layer	0.5mm
Bevel	Micro
Box Quantity	12 Planks/3.34m ²

Suitability/Application:
Commercial heavy duty use
Domestic extra heavy duty use



Slip Resistance/Result:
Oil Wet Ramp R10

Technical Specifications:
Page: 227

Carbo WP318



Size	915mm x 152mm (36" x 6")
Thickness	2.5mm
Wear Layer	0.5mm
Bevel	Micro
Box Quantity	24 Planks/3.34m ²

Suitability/Application:
Commercial heavy duty use
Domestic extra heavy duty use

Slip Resistance/Result:
Oil Wet Ramp R10

Technical Specifications:
Page: 227

Knight Tile Wood



48" x 7" (1219mm x 178mm)



Nordic Limed Oak **KP153-7**



White Painted Oak **KP105-7**



Coastal Blackbutt **KP157-7**



Coastline Oak **KP147-7**



Blond Character Oak **KP143-7**



Washed Character Oak **KP144-7**



Grey Limed Oak **KP138-7**



Rose Washed Oak **KP95-7**



Lime Washed Oak **KP99-7**



Pale Limed Oak **KP94-7**



Traditional Character Oak **KP146-7**



Classic Spotted Gum **KP149-7**



Light Worn Oak **KP104-7**



Mid Limed Oak **KP96-7**

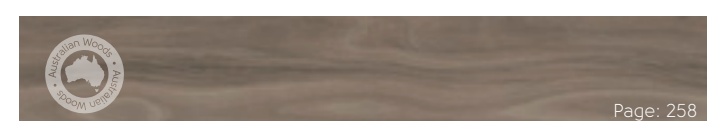

Urban Spotted Gum **KP141-7**

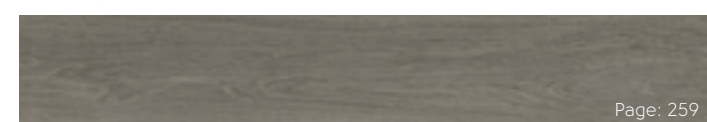

Shadow Studio Oak **KP150-7**

Knight Tile Wood

Our Knight Tile collection offers a range of wood look planks at our most affordable prices, ensuring there's something for everyone. Choose from a variety of design strips and borders to personalise your space (for full details on strips and borders please see page: 290).

Offering slim 915mm x 102mm and standard 915mm x 152mm plank sizes, the Knight Tile collection covers the full colour spectrum, including rustic, lime washed and white painted looks.



■ Grey Limed Oak KP138

	Standard	Result
Size	ISO 24342	See individual product pages
Thickness	ISO 24346	2.0 mm
Wear layer		0.3 mm
Surface treatment		K-Guard+ PU coating
Warranty	Commercial Domestic	10 year light commercial wear* Lifetime wear*
Bevelled edge		No
Standards	EN 649/EN ISO 10582 ASTM F1700	Pass Pass
Classification	ISO 10874 - Commercial ISO 10874 - Domestic	31: Commercial moderate 23: Domestic heavy
Reaction to fire	AS/NZS 9239.1:2010	CRF: 8.1 kW/m ² Smoke value: 42% min
Staining resistance	EN ISO 26987/EN 423 ASTM F925	Excellent Pass
Colour fastness to light	ISO 105-B02 ASTM F1515	Pass (≥ 6) Pass (< 8)
Abrasion resistance	EN 660-2 ISO 10582 ASTM D3884	Group T Type 1 Pass
Flexibility	ISO 24344	Pass
Dimensional stability	EN 434/ISO 23999 ASTM F2199	Pass (≤ 0.25%) Pass
Acoustic impact noise reduction	EN ISO 717-2/ EN ISO 140-8	ΔL _w = 1 dB**
Electrical behaviour body voltage	EN 1815	Pass
Indentation - residual	EN 433/ISO 24343-1 ASTM F1914	Pass (≤ 0.1 mm) Pass (< 8%)
Castor chair continuous use	EN 425/ISO 4918	Pass
Thermal resistance	ISO 8302	0.0100 m ² K/W Suitable for underfloor heating.
Slip resistance***	AS/NZS 4586:2013	See individual product pages
Adhesive	General use: High temperature:	Karndean Mega-Bond Karndean 8000 2-part Polyurethane
Recycling		Suitable
Environmental	Floorscore SCS- EC10.3-2014 v4.0	Indoor air quality certified; Compliant low emitting VOC emissions
Phthalate free		Yes

* Subject to terms. Please see our website.

** Result is Ln,w = 58 dB when installed on Regupol 4515 acoustic underlay.

*** Slip resistance is measured on ex-factory product. Slip resistance can be affected by surface contamination, use and how the product is maintained.

Nordic Limed Oak KPI53-7



White Painted Oak KPI105-7



Size	1219mm x 178mm (48" x 7")
Thickness	2.0mm
Wear Layer	0.3mm
Bevel	No
Box Quantity	20 Planks/4.335m ²

Suitability/Application:
Commercial light duty use
Domestic heavy duty use

Slip Resistance/Result:
Oil Wet Ramp R10

Technical Specifications:
Page: 243

Size	1219mm x 178mm (48" x 7")
Thickness	2.0mm
Wear Layer	0.3mm
Bevel	No
Box Quantity	20 Planks/4.335m ²

Suitability/Application:
Commercial light duty use
Domestic heavy duty use

Slip Resistance/Result:
Oil Wet Ramp R10

Technical Specifications:
Page: 243

Coastal Blackbutt KPI57-7



Coastline Oak KPI47-7



Size	1219mm x 178mm (48" x 7")
Thickness	2.0mm
Wear Layer	0.3mm
Bevel	No
Box Quantity	20 Planks/4.335m ²

Suitability/Application:

Commercial light duty use
Domestic heavy duty use

Slip Resistance/Result:

Oil Wet Ramp R10

Technical Specifications:

Page: 243

Size	1219mm x 178mm (48" x 7")
Thickness	2.0mm
Wear Layer	0.3mm
Bevel	No
Box Quantity	20 Planks/4.335m ²

Suitability/Application:

Commercial light duty use
Domestic heavy duty use

Slip Resistance/Result:

Oil Wet Ramp R10

Technical Specifications:

Page: 243

Blond Character Oak KPI43-7



Washed Character Oak KPI44-7



Size	1219mm x 178mm (48" x 7")
Thickness	2.0mm
Wear Layer	0.3mm
Bevel	No
Box Quantity	20 Planks/4.335m ²

Suitability/Application:
Commercial light duty use
Domestic heavy duty use

Slip Resistance/Result:
Oil Wet Ramp R10

Technical Specifications:
Page: 243

Size	1219mm x 178mm (48" x 7")
Thickness	2.0mm
Wear Layer	0.3mm
Bevel	No
Box Quantity	20 Planks/4.335m ²

Suitability/Application:
Commercial light duty use
Domestic heavy duty use

Slip Resistance/Result:
Oil Wet Ramp R10

Technical Specifications:
Page: 243

Grey Limed Oak KPI38-7



Rose Washed Oak KP95-7



Size	1219mm x 178mm (48" x 7")
Thickness	2.0mm
Wear Layer	0.3mm
Bevel	No
Box Quantity	20 Planks/4.335m ²

Suitability/Application:

Commercial light duty use
Domestic heavy duty use

Slip Resistance/Result:

Oil Wet Ramp R10

Technical Specifications:

Page: 243

Size	1219mm x 178mm (48" x 7")
Thickness	2.0mm
Wear Layer	0.3mm
Bevel	No
Box Quantity	20 Planks/4.335m ²

Suitability/Application:

Commercial light duty use
Domestic heavy duty use

Slip Resistance/Result:

Oil Wet Ramp R10

Technical Specifications:

Page: 243

Lime Washed Oak KP99-7



Pale Limed Oak KP94-7



Size	1219mm x 178mm (48" x 7")
Thickness	2.0mm
Wear Layer	0.3mm
Bevel	No
Box Quantity	20 Planks/4.335m ²

Suitability/Application:

Commercial light duty use
Domestic heavy duty use

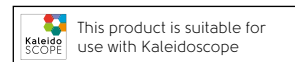

Slip Resistance/Result:

Oil Wet Ramp R10

Technical Specifications:

Page: 243

Size	1219mm x 178mm (48" x 7")
Thickness	2.0mm
Wear Layer	0.3mm
Bevel	No
Box Quantity	20 Planks/4.335m ²

Suitability/Application:

Commercial light duty use
Domestic heavy duty use

Slip Resistance/Result:

Oil Wet Ramp R10

Technical Specifications:

Page: 243

Traditional Character Oak KPI46-7



Classic Spotted Gum KPI49-7



Size	1219mm x 178mm (48" x 7")
Thickness	2.0mm
Wear Layer	0.3mm
Bevel	No
Box Quantity	20 Planks/4.335m ²

Suitability/Application:

Commercial light duty use
Domestic heavy duty use

Slip Resistance/Result:

Oil Wet Ramp R10

Technical Specifications:

Page: 243

Light Worn Oak KP104-7



Size	1219mm x 178mm (48" x 7")
Thickness	2.0mm
Wear Layer	0.3mm
Bevel	No
Box Quantity	20 Planks/4.335m ²

Suitability/Application:
Commercial light duty use
Domestic heavy duty use

Slip Resistance/Result:
Oil Wet Ramp R10

Technical Specifications:
Page: 243

Mid Limed Oak KP96-7



Size	1219mm x 178mm (48" x 7")
Thickness	2.0mm
Wear Layer	0.3mm
Bevel	No
Box Quantity	20 Planks/4.335m ²

Suitability/Application:
Commercial light duty use
Domestic heavy duty use

Slip Resistance/Result:
Oil Wet Ramp R10

Technical Specifications:
Page: 243

Urban Spotted Gum KPI41-7



Shadow Studio Oak KPI150-7



Size	1219mm x 178mm (48" x 7")
Thickness	2.0mm
Wear Layer	0.3mm
Bevel	No
Box Quantity	20 Planks/4.335m ²

Suitability/Application:

Commercial light duty use
Domestic heavy duty use

Slip Resistance/Result:

Oil Wet Ramp R10

Technical Specifications:

Page: 243

Size	1219mm x 178mm (48" x 7")
Thickness	2.0mm
Wear Layer	0.3mm
Bevel	No
Box Quantity	20 Planks/4.335m ²

Suitability/Application:

Commercial light duty use
Domestic heavy duty use

Slip Resistance/Result:

Oil Wet Ramp R10

Technical Specifications:

Page: 243

Opus Stone



457mm x 457mm (18" x 18")

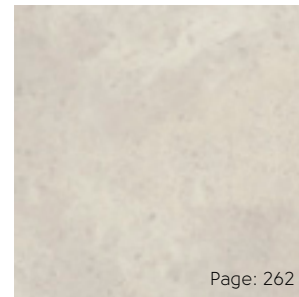

Page: 262

Luna SP111

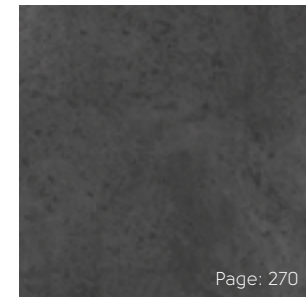

Page: 270

Ombra SP114

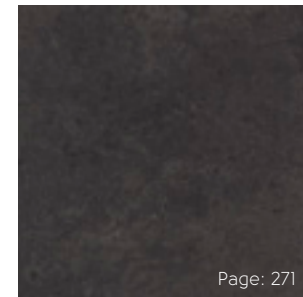

Page: 271

Nero SP115

457mm x 610mm (18" x 24")

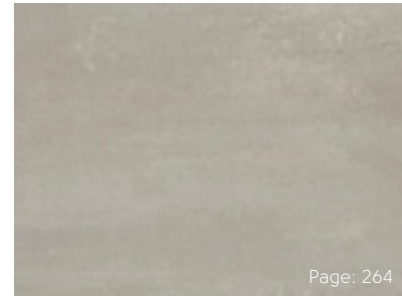

Page: 264

Mico SP211

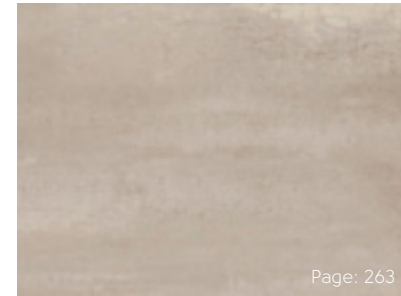

Page: 263

Terra SP212

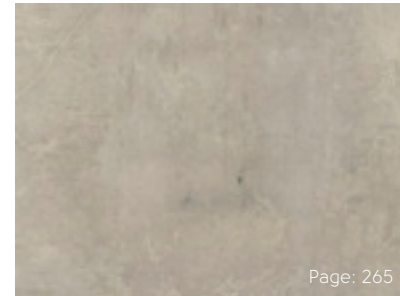

Page: 265

Argento SP217

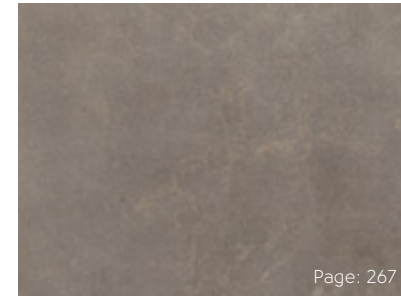

Page: 267

Fumo SP216

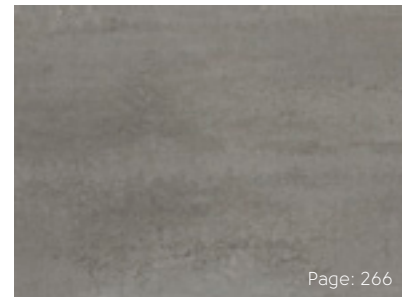

Page: 266

Urbus SP213

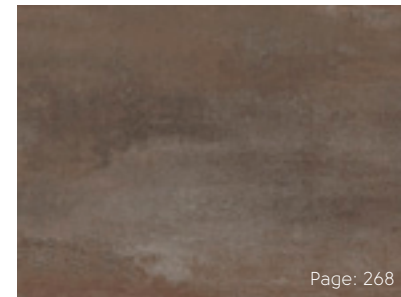

Page: 268

Forma SP214

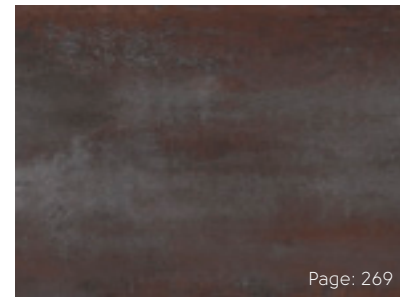

Page: 269

Ferra SP215

Opus Stone

The contemporary look of Opus is carried across to its stone range. These large tiles offer instant impact in any space. The 457mm x 457mm tiles in this collection offer varying shades of creamy whites and darker tones and the 457mm x 610mm tiles are available in four modern sealed concrete looks.

For grout strip options, please see page 291.



	Standard	Result
Size	ISO 24342	See individual product pages
Thickness	ISO 24346	2.5 mm
Wear layer		0.5 mm
Surface treatment		K-Guard+ PU coating
Warranty	Commercial Domestic	15 year wear* Lifetime wear*
Bevelled edge		Micro
Standards	ASTM F1700	Pass
Classification		Commercial heavy duty use Domestic extra heavy duty use
Reaction to fire	AS/NZS 9239.1:2010	CRF: >11 kW/m ² Smoke value: 93% min
Staining resistance	EN ISO 26987/EN 423 ASTM F925	Excellent Pass
Colour fastness to light	ISO 105-B02 ASTM F1515	≥7 <8
Abrasion resistance	EN 660-2 ISO 10582 ASTM D3884	Group T Type 1 Pass
Flexibility	ISO 24344	Pass
Dimensional stability	EN 434/ISO 23999 ASTM F2199	≤0.25% Pass
Acoustic impact noise reduction	EN ISO 717-2/ EN ISO 140-8	ΔL _w = 2 dB**
Electrical behaviour body voltage	EN 1815	Pass
Indentation - residual	EN 433/ISO 24343-1 ASTM F1914	≤0.1 mm <8%
Castor chair continuous use	EN 425/ISO 4918	Pass
Thermal resistance	ISO 8302	0.0120 m ² K/W Suitable for underfloor heating.
Slip resistance***	AS/NZS 4586:2013	R10
Adhesive	General use: High temperature:	Karndean Mega-Bond Karndean 8000 2-part Polyurethane
Recycling		Suitable
Environmental	Floorscore SCS- EC10.3-2014 v4.0	Indoor air quality certified: Compliant low emitting VOC emissions
Phthalate free		Yes

* Subject to terms. Please see our website.

** Result is Ln,w = 58 dB when installed on Regupol 4515 acoustic underlay.

*** Slip resistance is measured on ex-factory product. Slip resistance can be affected by surface contamination, use and how the product is maintained.

Luna SP111



Opus Stone

Terra SP212



Opus Stone

Size	457mm x 457mm (18" x 18")
Thickness	2.5mm
Wear Layer	0.5mm
Bevel	Micro
Box Quantity	16 Tiles/3.34m ²

Suitability/Application:
Commercial heavy duty use
Domestic extra heavy duty use



Slip Resistance/Result:
Oil Wet Ramp R10

Technical Specifications:
Page: 261

Decorative Strip Shown:
DS12 (3mm)

Size	457mm x 610mm (18" x 24")
Thickness	2.5mm
Wear Layer	0.5mm
Bevel	Micro
Box Quantity	12 Tiles/3.34m ²

Suitability/Application:
Commercial heavy duty use
Domestic extra heavy duty use

Slip Resistance/Result:
Oil Wet Ramp R10

Technical Specifications:
Page: 261

Decorative Strip Shown:
AF06 (3mm)

Mico SP211



Argento SP217



Opus Stone

Opus Stone

Size	457mm x 610mm (18" x 24")
Thickness	2.5mm
Wear Layer	0.5mm
Bevel	Micro
Box Quantity	12 Tiles/3.34m ²

Suitability/Application:
Commercial heavy duty use
Domestic extra heavy duty use

Slip Resistance/Result:
Oil Wet Ramp R10

Technical Specifications:
Page: 261
Decorative Strip Shown:
DS10 (3mm)

Size	457mm x 610mm (18" x 24")
Thickness	2.5mm
Wear Layer	0.5mm
Bevel	Micro
Box Quantity	12 Tiles/3.34m ²

Suitability/Application:
Commercial heavy duty use
Domestic extra heavy duty use

Slip Resistance/Result:
Oil Wet Ramp R10

Technical Specifications:
Page: 261
Decorative Strip Shown:
DS10 (3mm)

Urbus SP213



Fumo SP216



Size	457mm x 610mm (18" x 24")
Thickness	2.5mm
Wear Layer	0.5mm
Bevel	Micro
Box Quantity	12 Tiles/3.34m ²

Suitability/Application:
Commercial heavy duty use
Domestic extra heavy duty use



Slip Resistance/Result:
Oil Wet Ramp R10

Technical Specifications:
Page: 261

Decorative Strip Shown:
AF05 (3mm)

Size	457mm x 610mm (18" x 24")
Thickness	2.5mm
Wear Layer	0.5mm
Bevel	Micro
Box Quantity	12 Tiles/3.34m ²

Suitability/Application:
Commercial heavy duty use
Domestic extra heavy duty use

Slip Resistance/Result:
Oil Wet Ramp R10

Technical Specifications:
Page: 261

Decorative Strip Shown:
DS12 (3mm)

Forma SP214



Ferra SP215



Opus Stone

Opus Stone

Size	457mm x 610mm (18" x 24")
Thickness	2.5mm
Wear Layer	0.5mm
Bevel	Micro
Box Quantity	12 Tiles/3.34m ²

Suitability/Application:
Commercial heavy duty use
Domestic extra heavy duty use

Slip Resistance/Result:
Oil Wet Ramp R10

Technical Specifications:
Page: 261
Decorative Strip Shown:
AF02 (3mm)

Size	457mm x 610mm (18" x 24")
Thickness	2.5mm
Wear Layer	0.5mm
Bevel	Micro
Box Quantity	12 Tiles/3.34m ²

Suitability/Application:
Commercial heavy duty use
Domestic extra heavy duty use

Slip Resistance/Result:
Oil Wet Ramp R10

Technical Specifications:
Page: 261
Decorative Strip Shown:
Silver (3mm)

Ombra SP114



Nero SP115



Opus Stone

Opus Stone

Size	457mm x 457mm (18" x 18")
Thickness	2.5mm
Wear Layer	0.5mm
Bevel	Micro
Box Quantity	16 Tiles/3.34m ²

Suitability/Application:
Commercial heavy duty use
Domestic extra heavy duty use

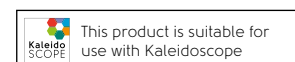

Slip Resistance/Result:
Oil Wet Ramp R10

Technical Specifications:
Page: 261

Decorative Strip Shown:
AF06 (3mm)

Size	457mm x 457mm (18" x 18")
Thickness	2.5mm
Wear Layer	0.5mm
Bevel	Micro
Box Quantity	16 Tiles/3.34m ²

Suitability/Application:
Commercial heavy duty use
Domestic extra heavy duty use

Slip Resistance/Result:
Oil Wet Ramp R10

Technical Specifications:
Page: 261

Decorative Strip Shown:
AF01 (3mm)

Knight Tile Stone



305mm x 457mm (12" x 18")

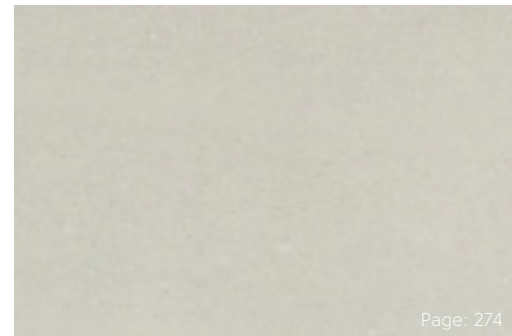

Honed Oyster Slate **ST17**

Page: 274

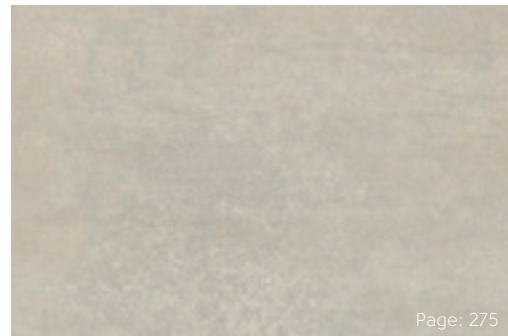

Dove Grey Concrete **ST21**

Page: 275

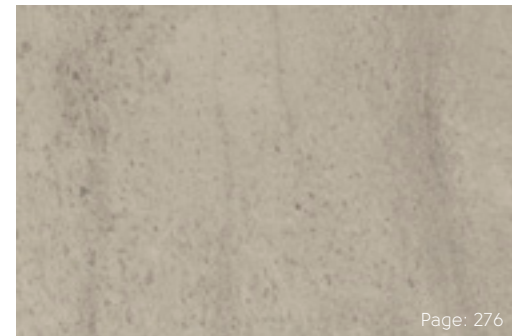

Honed Pebble Slate **ST20**

Page: 276



Smoked Concrete **ST22**

Page: 277

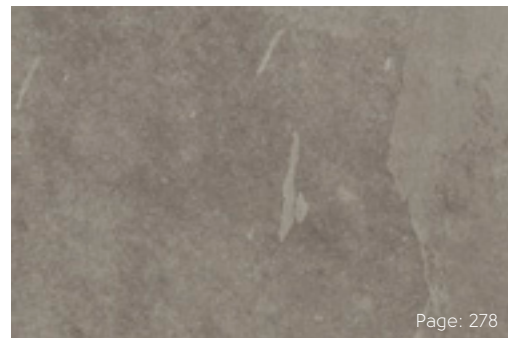

Grey Riven Slate **ST16**

Page: 278

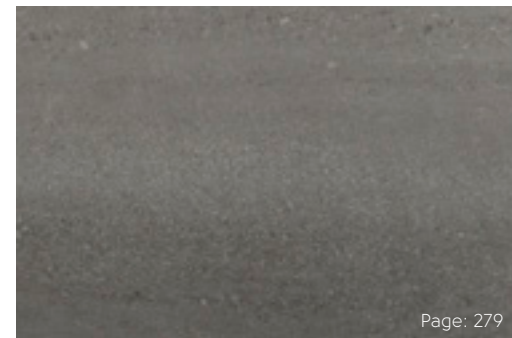

Honed Charcoal Slate **ST19**

Page: 279

Knight Tile Stone

Our Knight tile collection of stones offers a great selection of effects and styles. Each colour and design reflects a wide range of natural materials from classic pale to contemporary dark stones. The collection includes the classic tones of Grey Riven slate to the modern look of Honed Oyster Slate and the bold characteristics of Honed Charcoal Slate, giving a collection that covers wide variety of interior styles.



■ Honed Pebble Slate **ST20** with D&I 3mm design strip

	Standard	Result
Size	ISO 24342	See individual product pages
Thickness	ISO 24346	2.0 mm
Wear layer		0.3 mm
Surface treatment		K-Guard+ PU coating
Warranty	Commercial Domestic	10 year light commercial wear* Lifetime wear*
Bevelled edge		No
Standards	EN 649/EN ISO 10582 ASTM F1700	Pass Pass
Classification	ISO 10874 - Commercial ISO 10874 - Domestic	31: Commercial moderate 23: Domestic heavy
Reaction to fire	AS/NZS 9239.1:2010	CRF: 8.1 kW/m ² Smoke value: 42% min
Staining resistance	EN ISO 26987/EN 423 ASTM F925	Excellent Pass
Colour fastness to light	ISO 105-B02 ASTM F1515	Pass (≥ 6) Pass (< 8)
Abrasion resistance	EN 660-2 ISO 10582 ASTM D3884	Group T Type 1 Pass
Flexibility	ISO 24344	Pass
Dimensional stability	EN 434/ISO 23999 ASTM F2199	Pass (≤ 0.25%) Pass
Acoustic impact noise reduction	EN ISO 717-2/ EN ISO 140-8	ΔL _w = 1 dB**
Electrical behaviour body voltage	EN 1815	Pass
Indentation - residual	EN 433/ISO 24343-1 ASTM F1914	Pass (≤ 0.1 mm) Pass (< 8%)
Castor chair continuous use	EN 425/ISO 4918	Pass
Thermal resistance	ISO 8302	0.0100 m ² K/W Suitable for underfloor heating.
Slip resistance***	AS/NZS 4586:2013	See individual product pages
Adhesive	General use: High temperature:	Karndean Mega-Bond Karndean 8000 2-part Polyurethane
Recycling		Suitable
Environmental	Floorscore SCS- EC10.3-2014 v4.0	Indoor air quality certified: Compliant low emitting VOC emissions
Phthalate free		Yes

* Subject to terms. Please see our website.

** Result is L_{n,w} = 58 dB when installed on Regupol 4515 acoustic underlay.

*** Slip resistance is measured on ex-factory product. Slip resistance can be affected by surface contamination, use and how the product is maintained.

Honed Oyster Slate ST17



Dove Grey Concrete ST21



Size	305mm x 457mm (12" x 18")
Thickness	2.0mm
Wear Layer	0.3mm
Bevel	No
Box Quantity	24 Tiles/3.34m ²

Suitability/Application:
Commercial light duty use
Domestic heavy duty use

Slip Resistance/Result:
Oil Wet Ramp R9

Technical Specifications:
Page: 273
Decorative Strip Shown:
ST3 (3mm)

Size	305mm x 457mm (12" x 18")
Thickness	2.0mm
Wear Layer	0.3mm
Bevel	No
Box Quantity	24 Tiles/3.34m ²

Suitability/Application:
Commercial light duty use
Domestic heavy duty use

Slip Resistance/Result:
Oil Wet Ramp R9

Technical Specifications:
Page: 273
Decorative Strip Shown:
ST3 (3mm)

Honed Pebble Slate ST20



Smoked Concrete ST22



Size	305mm x 457mm (12" x 18")
Thickness	2.0mm
Wear Layer	0.3mm
Bevel	No
Box Quantity	24 Tiles/3.34m ²

Suitability/Application:
Commercial light duty use
Domestic heavy duty use

Slip Resistance/Result:
Oil Wet Ramp R9

Technical Specifications:
Page: 273
Decorative Strip Shown:
ST3 (3mm)

Size	305mm x 457mm (12" x 18")
Thickness	2.0mm
Wear Layer	0.3mm
Bevel	No
Box Quantity	24 Tiles/3.34m ²

Suitability/Application:
Commercial light duty use
Domestic heavy duty use

Slip Resistance/Result:
Oil Wet Ramp R9

Technical Specifications:
Page: 273
Decorative Strip Shown:
ST3 (3mm)

Grey Riven Slate ST16



Size	305mm x 457mm (12" x 18")
Thickness	2.0mm
Wear Layer	0.3mm
Bevel	No
Box Quantity	24 Tiles/3.34m ²

Suitability/Application:
Commercial light duty use
Domestic heavy duty use

Slip Resistance/Result:
Oil Wet Ramp R9

Technical Specifications:
Page: 273
Decorative Strip Shown:
ST3 (3mm)

Honed Charcoal Slate ST19



Size	305mm x 457mm (12" x 18")
Thickness	2.0mm
Wear Layer	0.3mm
Bevel	No
Box Quantity	24 Tiles/3.34m ²

Suitability/Application:
Commercial light duty use
Domestic heavy duty use

Slip Resistance/Result:
Oil Wet Ramp R9

Technical Specifications:
Page: 273
Decorative Strip Shown:
ST3 (3mm)

Kaleidoscope



Apex

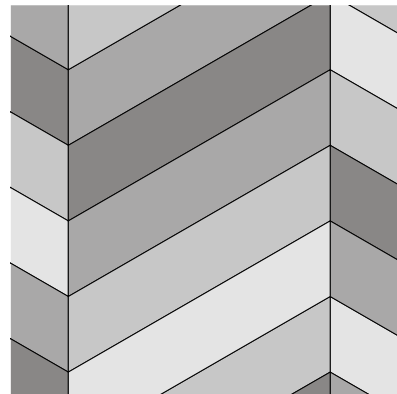
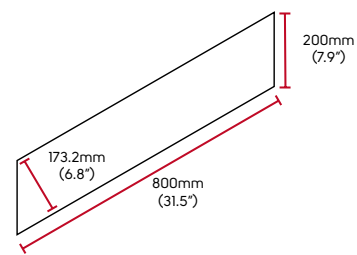

Cubix

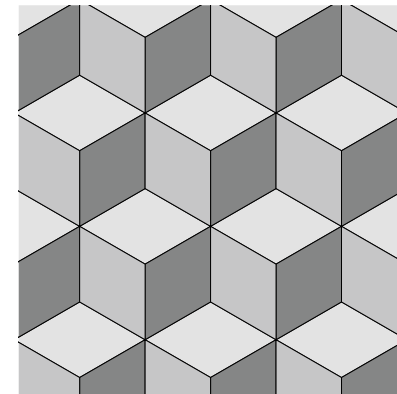
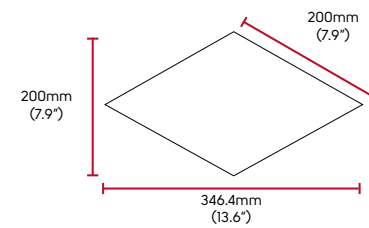

Hexa

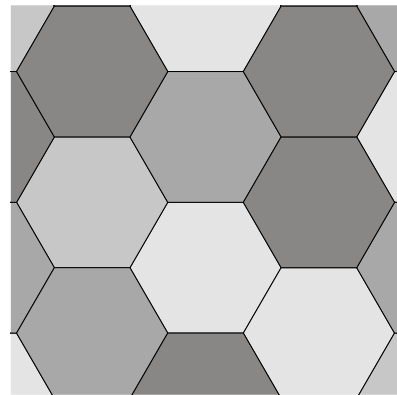
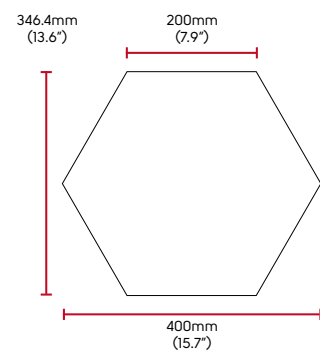

Pennon*

*available in Half Pennon for wood designs

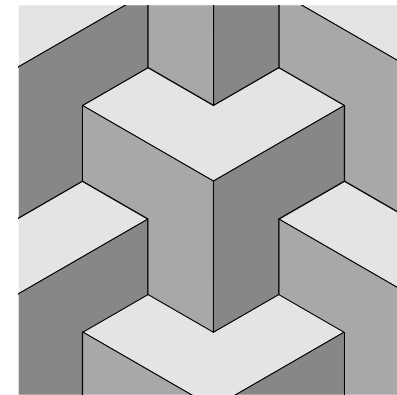
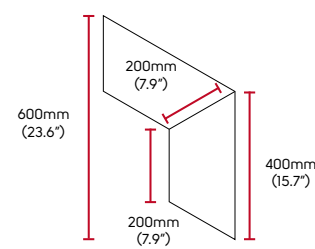

Pyramid

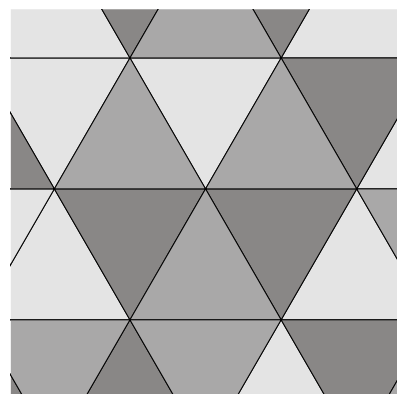
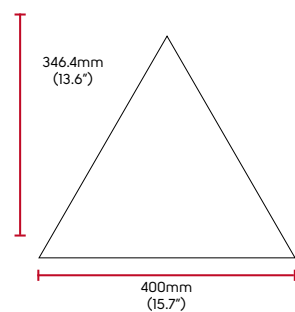

Tripoint

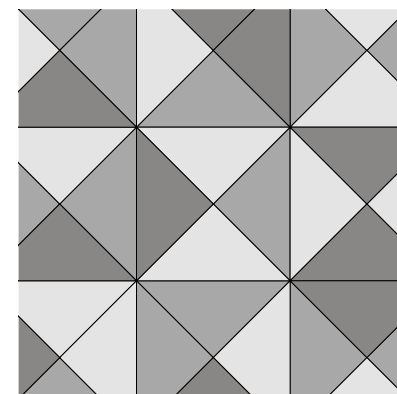
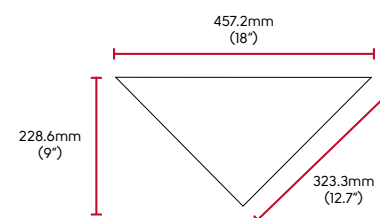

Kaleidoscope

Kaleidoscope is an innovative collection of modular designs custom cut in compatible geometric formats; utilising our most popular colours from our standard ranges including wood, stone, and new solids. It gives architects, interior designers, and contractors the freedom to explore a world of patterns and shapes to create compelling spaces through designflooring. With over 100 different colours to choose from, the precise technical specification for your Kaleidoscope product will depend on your final selection. Kaleidoscope needs to be ordered from the UK and is not stocked locally. Please contact your business manager for further details and how to order.



Cubix with Luna SP111, Urbus SP213 and Ombra SP114

Apex



Cubix

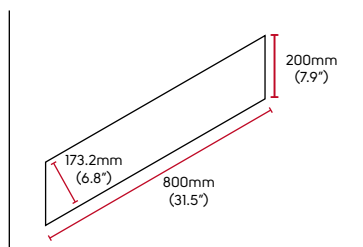
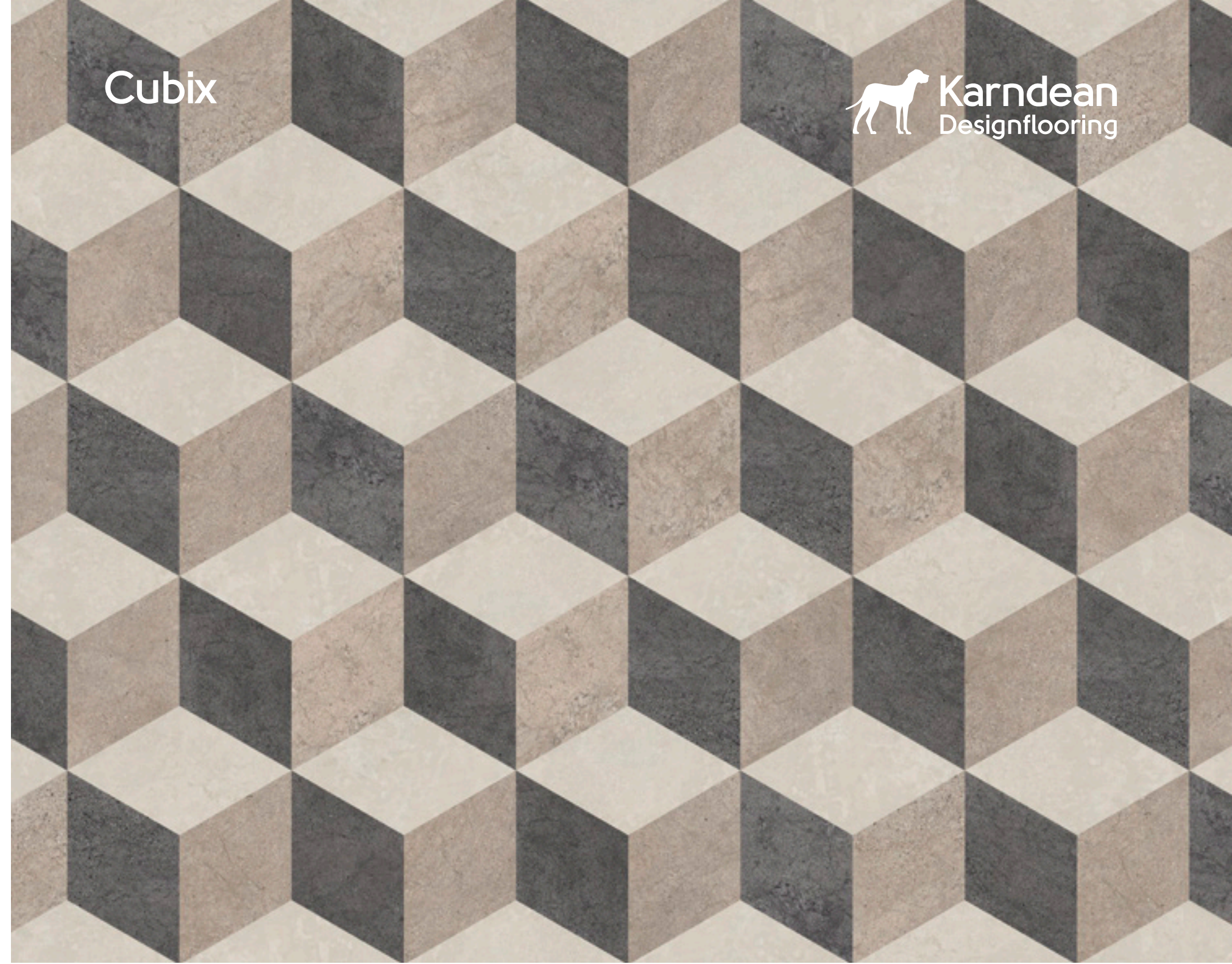

Products used in above design:

- Rose Washed Oak KP95

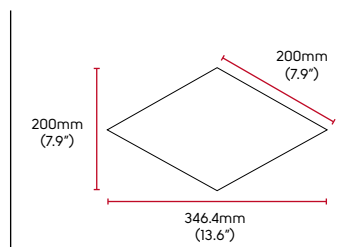

Products used in above design:

- Balin Stone ST8
- Portland Stone ST13
- Cumbrian Stone ST14

Hexa

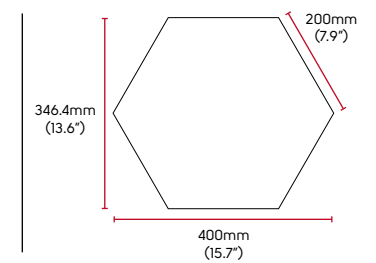

Products used in above design:

- Balin Stone ST8
- Portland Stone ST13

Pyramid

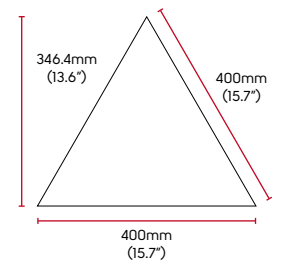

Products used in above design:

- White Washed Oak VGW80T
- Frosted Birch VGW83T
- Ebony VGW89T

Tripoint

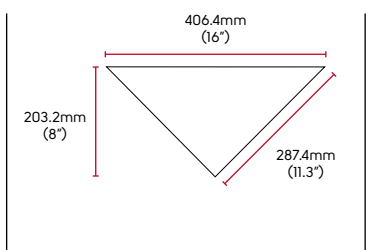

Products used in above design:

- White Painted Oak KP105
- Light Worn Oak KP104
- Mid Worn Oak KP103









Design components

Design strips

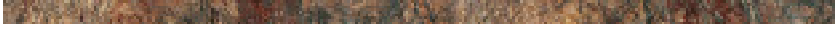

Design strips are narrow pieces of luxury vinyl tile which can be put between our planks and tiles. These design strips can add realistic touches such as a grout effect in between tiles (see page 291), or incorporated into a plank design to create a ships decking effect. Available in a variety of colours and widths, our strips won't fade or stain and they don't have to be sealed.

The choice of colour is completely up to you. You may want to choose a design strip in a colour that matches the wall tiles, for example, to help tie in elements that are already in the room to the new floor. Alternatively, you could choose a colour which helps the overall look of your floor feel either more contemporary or more traditional, enhancing the design of the product you've chosen.

Design strip...		widths...	compatible with...
Utah REN34		3mm, 5mm & 10mm	 Available for use with Opus floors.
Gold J86			
Beechwood P504			
Burnt Ash MP3			
Golden Teak P702			
Mahogany P802			
Mercury J89			
Concrete DS12			
Clay DS15			
Chalk DS10			

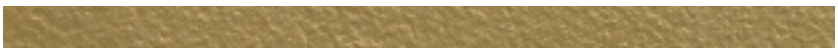







Design strip...		widths...	compatible with...
Luna DS10		3mm	 Available for use with all our floors.
Soapstone ST5		3mm, 5mm & 10mm	
Aurora ST3			
Orkney T100		3mm, 5mm, 10mm & 30mm	
Cedar KP35		3mm, 5mm & 10mm	
Sienna KP107			

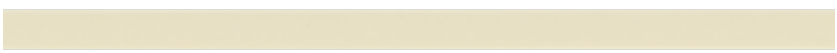





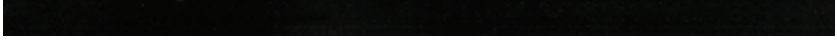

Metallic strip...		widths...	compatible with...
Copper		3mm, 5mm & 10mm	 Available for use with Art Select, Opus and Knight Tile floors.
Gold			
Silver			

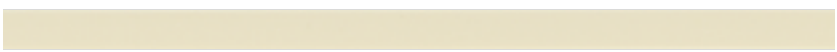
Grout strip...		widths...	compatible with...
Beige AF06		3mm	 Available for use with Opus floors.
Ivory AF05			
Taupe AF04			
Brown AF02			
Chestnut AF07			
Black AF01			

* Due to Art Select's bevelled edge, these strips can only be used between planks or tiles and not along a cut edge.

Design strips continued

Feature strip...		widths...	compatible with...
Beige		5mm	 Available for use with Art Select* and Opus floors.
Stone			
Light Grey			
Grey			
Gold			
Light Brown			
Chocolate			
Black			

Feature strip...		widths...	compatible with...
Beige KFS23 ††		5mm	 Available for use with Knight Tile floors.
Stone KFS22 †			
Light Grey KFS17 ††			
Grey KFS15 ^			
Gold KFS18 †			
Light Brown KFS21 †			
Chocolate KFS25 ††			
Black KFS10 ^			

† Colours available in Australia only.

†† Colours available in New Zealand only.

^ Colours also compatible with Van Gogh products in New Zealand only.

* Due to Art Select's bevelled edge, these strips can only be used between planks or tiles and not along a cut edge.

Decorative borders

Define the perimeter of your space with decorative style. We offer a variety of decorative borders to complement our Gluedown ranges. Choose a sleek, single tone option, such as Accent or a strong, distinctive pattern like Diamond.

Border...		code...	use with...	made up of...	width...	length...
Dark Mackintosh		MACKSTI413BD	 ST13	ST14/ST13/DS10	51mm	940mm
			 ST14			
Dark Mosaic		MOSASTI314100BD	 ST13	ST13/ST14/TI00/DS10	25mm	900mm
			 ST14			
Light Mackintosh		MACKSTI314BD	 ST13	ST13/ST14/DS10	51mm	940mm
			 ST14			
Light Mosaic		MOSASTI11213BD	 ST11	ST11/ST12/ST13/DS10	25mm	900mm
			 ST12			
			 ST13			



Resources

Adhesives

We recommend that you use our range of environmentally friendly Karndeans Designflooring adhesives that are available for you to order. The type of adhesive required will depend on the application and location of the installation.



Karndeans Mega-Bond Adhesive

Karndeans Mega-Bond is a non-solvent and low odour adhesive suitable for indoor use. Mega-Bond is used for all Karndeans LVT glue backed installations. Apply Mega-Bond using a V1 1.6mm x 1.6mm notched trowel and install into a wet film (do not let the adhesive tack-up). Refer to AS/NZS 1884 for best practice subfloor preparation.

4ltr 16-20m ² coverage	10ltr 40-50m ² coverage	15ltr 60-80m ² coverage
-----------------------------------	------------------------------------	------------------------------------







Karndeans Hi-Tack PS

Karndeans Hi-Tack PS is a pressure sensitive 'peel and release' adhesive used for installing LooseLay tiles and planks. Use a roller or notched trowel to apply Hi-Tack PS evenly over the subfloor allowing it to dry into a 'clear film' before installation.

4ltr 32m ² coverage	15ltr 120m ² coverage
--------------------------------	----------------------------------





Karndeans 8000 2-Part Waterproof / High Temperature Adhesive

Karndeans' 2-Part Polyurethane is a waterproof, high temperature adhesive for use in circumstances when excessive water puddling or high temperatures are expected. It can also be used for adhesion to non-porous substrates such as steel. When mixing parts 'A' & 'B' together an extreme permanent chemical bond is achieved.

5kg 10m ² coverage	Australia only 10kg 20m ² coverage
-------------------------------	---

A great benefit of all Karndeans adhesives is that each formulation prevents spillages from seeping into tile/plank joints. In the case of Mega-Bond and Hi-Tack PS, a polymer sealer is incorporated.

Environmentally friendly: ✓ VOC Compliant ✓ Low Odour ✓ Non-Solvent

Cleaning & maintenance

Cleaning guide

Karndeans floors are very durable, but as with any flooring, they need to be looked after. There are many ways to protect your Karndeans floor and prevent damage. We recommend following our Cleaning & Maintenance instructions and reading our Maintenance Advice for helpful hints and tips on how to care for your floor.

Maintaining your floor

The floor should be cleaned regularly, though the frequency will depend upon the level of traffic across the floor and the amount of dust and dirt transferred from the surrounding environment.

1. Remove loose dust and dirt from the floor using a soft brush or dust mop.
2. Dilute **Karndeans Clean** in accordance with the label instructions.
3. Liberally apply the cleaning solution over the entire floor using a clean mop, then soak up the cleaning solution using a damp (not wet) mop and leave to dry.
4. Thoroughly clean the mop with cold running water.

Commercial **Karndeans Clean** can be used with automatic cleaning appliances (e.g. scrubbing machines), especially for larger areas or for the removal of stubborn dirt.



Refreshing your floor

Over time, heavy traffic will wear at the surface of your Karndeans floor. To restore your floor, we recommend the use of **Karndeans Remove** and **Karndeans Refresh**.

Before applying Karndeans Remove:

1. Remove all free-standing objects from the floor.
2. Vacuum or clean any entrance matting or rugs and set aside.
3. Remove loose dust and dirt from the floor using a soft brush or dust mop.

Applying Karndeans Remove using a mop and scrubbing pad:

1. Mix **Karndeans Remove** in accordance with the label instructions.
2. Apply cleaning solution to the floor using a mop, working in an area no larger than 16' x 16' (5m x 5m) at a time.
3. Allow the solution to remain on the floor for approximately 10 minutes, but do not allow it to dry.
4. Scrub the floor using a white scrubbing pad fitted to an applicator.

Applying Karndeans Remove using a rotary scrubber:

1. Mix **Karndeans Remove** in accordance with the label instructions and pour into rotary scrubber machine.
2. Scrub the floor using the rotary scrubber fitted with a red scrubbing pad. For the edges of the floor and hard to reach areas, use a white scrubbing pad fitted to the end of an applicator.

NOTE: Rotary scrubber should not exceed 175 rpm.

Removal of Karndeans Remove:

1. Remove all residue with a wet vacuum or mop, and rinse the floor using clean water.
2. After the floor has dried, check to ensure that all residue has been removed.
3. Equipment should be cleaned in cold running water and stored safely.

Applying Karndeans Refresh:

When using **Karndeans Refresh**, avoid (where possible) strong sunlight and drafts and ensure all under floor heating is switched off before starting work.

1. Using a lint free mop, apply undiluted **Karndeans Refresh** in a thin, even coat using overlapping strokes. Where possible, work parallel to the main light source (e.g. window).
2. Allow the floor to dry for approximately 30 minutes.
3. Apply a second coat of **Karndeans Refresh**, working in the opposite direction to the first coat.
4. Allow the floor to dry for at least six hours, preferably overnight.
5. Thoroughly clean the mop with cold running water.



Customer support

We pride ourselves on offering quick, easy and reliable support – because we respect your time. We keep unparalleled stock levels across our Melbourne and Auckland distribution centres and are focused on stocking for customer needs, so you can rest assured that your order can be delivered in as little as a few days.

Your Karndean Commercial Business Manager (CBM) is your first point of contact, available to answer any questions and get you the materials you need to complete your projects on time, from technical datasheets to our EPD, and everything in between.

Our Customer Service department is available to assist you Monday through to Friday (AUS: 6.30am-5.30pm AEST and NZ: 8.30am-7.30pm) over the phone to check stock, place an order, request samples or literature, and to ask any additional questions.

For installation questions or for assistance on the job, contact our Customer Service department and ask for our Technical Support team.



**Not sure who to call? Give our Customer Service line a call
AUS: 1800 331 170 / NZ: 0800 442 101 and we can point you in the right direction.**

Continuing Professional Development (CPDs)

As a design driven company, we look to the future to develop products that will complement industry trends, and having specialised in luxury vinyl for more than 45 years we know the ins and outs of luxury vinyl to share about our industry. Our CPD program offers a variety of courses to educate architects and designers on the latest trends and useful information relevant to luxury vinyl and interior design.

**To enquire about our CPD program give our Customer Service department a call,
AUS: 1800 331 170 / NZ: 0800 442 101**



Sample service

Product samples are an integral part of putting together a proper proposal. We have 1/4 size product samples available to order, so whether you're building a project moodboard or want to compare product colours and finishes, we have the materials you need. Do you specify Karndean Designflooring often? Ask your CBM about acquiring a full set of our architectural presenters for your library.



Warranty

Definitions

1. "Wear out" is defined as the wear-down of the surface wear layer to the extent that no pattern is any longer apparent.
2. "Lifetime" is defined as 35 years. The warranty is fully transferable to the next owner as long as the floor is used as specified for the room type.
3. "Commercial" installation is defined as one in which business is conducted.
4. "Residential" installation is defined as a private domestic residence.

Scope

Used in Commercial premises, Karndean (hereinafter referred to as "the Company") offers the following product warranties against product wear-out and manufacturing defects:

- Knight Tile 10-years commercial light duty
- Van Gogh 15-years commercial heavy duty
- Opus 15-years commercial heavy duty
- Art Select 20-years commercial heavy duty
- LooseLay 15-years commercial heavy duty
- Korlok 15-years commercial heavy duty
- Kaleidoscope 10-years commercial heavy duty

Used in Residential premises, the Company offers a lifetime product warranty against product wear-out and manufacturing defects.

Conditions

The warranty is conditional on the following having been met:

1. The product has been installed to the AS/NZS Standard 1884 Floor coverings - Resilient sheet & tile - Installation practices and the Company's instructions, both current at the time of installation.
2. The subfloor meets the building standard under AS/NZS 1884 current at the time of

installation and the appropriate adhesives were used that were recommended for the application.

3. The product used has been correctly specified for the use of room or rooms in which it was installed.
4. Maintenance is according to the Company's cleaning and maintenance instructions.

Exclusions

The following exclusions shall apply:

1. Defects caused by incorrect installation and/or incorrect subfloor preparation, including insufficient attention to subfloor dampness.
2. Any accidental damage such as fire, flood or lack of barrier matting at any external entrance and the like.
3. Any claim resulting from a manufacturing defect, which is not notified to the Company within six (6) months of installation.
4. Damage caused due to improper use or improper maintenance.
5. Damage caused by stains, excessive heat, cuts, scratches and/or other abuses that the floor may be subjected to during usage not determined as fair wear and tear.
6. Fading and discoloration.
7. Damage caused by indentation and abrasion: e.g. unprotected castor wheels, furniture legs, high and spiked heel footwear.
8. High temperature areas where the mandatory use of a high-temperature 2-part adhesive was not used as defined in the Company's "Dry-Back LVT" installation instructions.
9. Exceptional traffic and/or high temperature areas where the mandatory use of a pressure sensitive or high-temperature 2-part adhesive was not used as defined in the Company's "LooseLay" installation instructions.

10. For products with a click mechanism, damage to the click mechanism or associated damage.

Claims

1. All claims must be submitted to the retailer from which you bought the product. The retailer will liaise with the Company on your behalf. If the retailer is no longer in business then you should make your claim directly to the Company in writing, to the address at the foot of this document.
2. Claims must be made as soon as they become apparent.
3. The Company will require information on the claim, including a copy of the invoice, product detail, installation and subfloor information, samples removed from the installation, photographs and a report of the defect.
4. Once a claim is raised the Company will carry out an investigation and satisfying themselves that the problem is their responsibility, will replace any defective material at no charge with the same or similar product. If requested you must send these materials to the Company at your cost
5. The Company will also reimburse a proportionate cost towards labour, uplift and re-installation, providing costs are agreed between the parties before work commences.

This warranty is in addition to and does not affect your statutory rights. Our goods come with guarantees that cannot be excluded under the Australian Consumer Law/NZ Consumer Guarantees Act 1993. You are entitled to a replacement or refund for a major failure and compensation for any other reasonably foreseeable loss or damage. You are also entitled to have the goods repaired or replaced if the goods fail to be of acceptable quality and the failure does not amount to a major failure.

Product index by code

Wood

■ AP01 Blond Oak.....	201	■ LLP156 Hamden.....	67	■ RL03 Autumn Oak.....	190	■ VGW103T Northern Spotted Gum.....	219
■ AP02 Auburn Oak.....	202	■ LLP157 Bridgeport.....	63	■ RL04 Winter Oak.....	191	■ VGW107T Blush Oak.....	206
■ AP03 Black Oak.....	203	■ LLP301 Twilight Oak.....	57	■ SCB-KP94 Pale Limed Oak.....	177	■ VGW110T Greige Oak.....	212
■ EW01 Hickory Paprika.....	192	■ LLP302 Raven Oak.....	58	■ SCB-KP95 Rose Washed Oak.....	175	■ VGW111T Light Distressed Oak.....	208
■ EW02 Hickory Peppercorn.....	194	■ LLP304 Weathered Heart Pine.....	44	■ SCB-KP96 Mid Limed Oak.....	181	■ VGW112T Misty Grey Oak.....	214
■ EW03 Hickory Nutmeg.....	193	■ LLP306 Pearl Oak.....	41	■ SCB-KP99 Lime Washed Oak.....	176	■ VGW127T Natural Maple.....	216
■ HC01 Dawn Oak.....	195	■ LLP308 French Grey Oak.....	49	■ SCB-KP104 Light Worn Oak.....	180	■ VGW128T Smoked Maple.....	223
■ HC02 Morning Oak.....	196	■ LLP310 Champagne Oak.....	43	■ SCB-KP105 White Painted Oak.....	169	■ VGW129T Washed Blackbutt.....	215
■ HC03 Dusk Oak.....	197	■ LLP311 Bleached Tasmanian Oak.....	40	■ SCB-KP138 Grey Limed Oak.....	174	■ VGW130T Eastern Blackbutt.....	213
■ HC04 Sundown Oak.....	198	■ LLP312 Tasmanian Oak.....	47	■ SCB-KP141 Urban Spotted Gum.....	182	■ VGW131T River Spotted Gum.....	218
■ HC05 Evening Oak.....	199	■ LLP313 North Coast Blackbutt.....	42	■ SCB-KP143 Blond Character Oak.....	248	■ VGW132T Marron Elm.....	224
■ HC06 Midnight Oak.....	200	■ LLP314 Embered Blackbutt.....	54	■ SCB-KP144 Washed Character Oak.....	173	■ VGW133T Millstone Sycamore.....	207
■ KP94-7 Pale Limed Oak.....	253	■ LLP316 Mountain Spotted Gum.....	56	■ SCB-KP146 Traditional Character Oak.....	178	■ VGW134T Nocturne Oak.....	222
■ KP95-7 Rose Washed Oak.....	251	■ LLP317 Lemon Spotted Gum.....	46	■ SCB-KP147 Coastline Oak.....	171	■ VGW135T Tranquil Oak.....	209
■ KP96-7 Mid Limed Oak.....	257	■ LLP325 Honey Ironbark.....	51	■ SCB-KP149 Classic Spotted Gum.....	179	■ WP311 Grano.....	231
■ KP99-7 Lime Washed Oak.....	252	■ LLP326 Ochre Ironbark.....	55	■ SCB-KP150 Shadow Studio Oak.....	183	■ WP312 Palleo.....	230
■ KP104-7 Light Worn Oak.....	256	■ LLP327 Natural Ironbark.....	59	■ SCB-KP153 Nordic Limed Oak.....	168	■ WP313 Ignea.....	238
■ KP105-7 White Painted Oak.....	245	■ LLP328 Blended Ironbark.....	48	■ SCB-KP157 Coastal Blackbutt.....	170	■ WP315 Aurum.....	237
■ KP138-7 Grey Limed Oak.....	250	■ LLP329 Pure Fabric Oak.....	45	■ SCB-VGW81T Country Oak.....	151	■ WP316 Rubra.....	239
■ KP141-7 Urban Spotted Gum.....	258	■ LLP331 Shadow Fabric Oak.....	50	■ SCB-VGW82T Distressed Oak.....	161	■ WP318 Carbo.....	241
■ KP143-7 Blond Character Oak.....	248	■ LLP334 Australian Wormy Chestnut.....	53	■ SCB-VGW84T Birch.....	150	■ WP319 Talpa.....	234
■ KP144-7 Washed Character Oak.....	173	■ LLP335 Weathered American Pine.....	52	■ SCB-VGW85T French Oak.....	157	■ WP329 Bleached Grey Walnut.....	236
■ KP146-7 Traditional Character Oak.....	254	■ RKP8101 Baltic Washed Oak.....	119	■ SCB-VGW86T Classic Oak.....	160	■ WP411 Niveus.....	233
■ KP147-7 Coastline Oak.....	247	■ RKP8103 Warm Ash.....	114	■ SCB-VGW89T Ebony.....	165	■ WP413 Magna.....	235
■ KP149-7 Classic Spotted Gum.....	179	■ RKP8104 Washed Grey Ash.....	120	■ SCB-VGW103T Northern Spotted Gum.....	159	■ WP414 Argen.....	240
■ KP150-7 Shadow Studio Oak.....	183	■ RKP8105 Texas White Ash.....	111	■ SCB-VGW107T Blush Oak.....	146	■ WP421 Rubesco.....	229
■ KP153-7 Nordic Limed Oak.....	168	■ RKP8106 Smoked Blackbutt.....	129	■ SCB-VGW110T Greige Oak.....	152	■ WP422 Columba.....	228
■ KP157-7 Coastal Blackbutt.....	168	■ RKP8108 Washed Butternut.....	113	■ SCB-VGW111T Light Distressed Oak.....	148	■ WP423 Avena.....	232
■ LLP92 Country Oak.....	66	■ RKP8112 Baltic Mistral Oak.....	126	■ SCB-VGW112T Misty Grey Oak.....	154		
■ LLP95 Ashland.....	62	■ RKP8116 Canadian Urban Oak.....	115	■ SCB-VGW127T Natural Maple.....	156		
■ LLP102 Heritage Oak.....	78	■ RKP8118 Warm Spotted Gum.....	116	■ SCB-VGW128T Smoked Maple.....	163		
■ LLP105 Vintage Timber.....	75	■ RKP8119 Weathered Spotted Gum.....	117	■ SCB-VGW129T Washed Blackbutt.....	155		
■ LLP108 Providence.....	71	■ RKP8120 Australian Ghost Gum.....	121	■ SCB-VGW130T Eastern Blackbutt.....	153		
■ LLP109 Stamford.....	74	■ RKP8121 Natural Blackbutt.....	118	■ SCB-VGW131T River Spotted Gum.....	158		
■ LLP112 Hartford.....	76	■ RKP8201 Frosted Acacia.....	110	■ SCB-VGW132T Marron Elm.....	164		
■ LLP113 Cambridge.....	72	■ RKP8203 Shadow Oak.....	122	■ SCB-VGW133T Millstone Sycamore.....	147		
■ LLP142 Sicilia.....	70	■ RKP8205 Nimbus Oak.....	123	■ SCB-VGW134T Nocturne Oak.....	162		
■ LLP146 Budelli.....	69	■ RKP8207 Light Barnwood.....	124	■ SCB-VGW135T Eastern Blackbutt.....	149		
■ LLP147 Lampione.....	68	■ RKP8208 Silver Barnwood.....	125	■ VGW81T Country Oak.....	211		
■ LLP148 Linosa.....	79	■ RKP8210 Carbon Oak.....	128	■ VGW82T Distressed Oak.....	221		
■ LLP150 Levanzo.....	73	■ RKP8213 Stained Acacia.....	127	■ VGW84T Birch.....	210		
■ LLP152 Waterbury.....	64	■ RKP8216 Grey Brushed Oak.....	112	■ VGW85T French Oak.....	217		
■ LLP153 Brockton.....	65	■ RL01 Spring Oak.....	188	■ VGW86T Classic Oak.....	220		
■ LLP154 Danbury.....	77	■ RL02 Summer Oak.....	189	■ VGW89T Ebony.....	225		

Stone

■ LLT201 Colorado.....	84	■ ST21 Dove Grey Concrete.....	275
■ LLT203 Madison.....	93	■ ST22 Smoked Concrete.....	277
■ LLT208 Tino.....	86		
■ LLT209 Capri.....	83		
■ LLT210 Nisida.....	90		
■ LLT211 Vulcano.....	92		
■ LLT212 Dakota.....	85		
■ LLT213 Maine.....	82		
■ LLT216 Utah.....	88		
■ LLT217 Vermont.....	91		
■ LLT218 Ontario.....	89		
■ LLT219 Quebec.....	87		
■ RKT2409 Oxford Grey.....	142		
■ RKT2410 Pebble Grey.....	139		
■ RKT2411 Sandstorm.....	138		
■ RKT2412 Smoke.....	135		
■ RKT2413 Palazzo Marble.....	132		
■ RKT2414 Mezzo Perla.....	133		
■ RKT2415 Mezzo Grigio.....	137		
■ RKT3006-G Black Sands.....	143		
■ RKT3014-G Urban Grey.....	141		
■ RKT3015-G Natural Ecru.....	136		
■ RKT3016-G Pumice Stone.....	134		
■ RKT3017-G River Stone.....	140		
■ SCB-ST16 Grey Riven Slate.....	190		
■ SCB-ST17 Honed Oyster Slate.....	186		
■ SCB-ST19 Honed Charcoal Slate.....	191		
■ SCB-ST20 Honed Pebble Slate.....	188		
■ SCB-ST21 Dove Grey Concrete.....	187		
■ SCB-ST22 Smoked Concrete.....	189		
■ SPI11 Luna.....	262		
■ SPI14 Ombra.....	270		
■ SPI15 Nero.....	271		
■ SP211 Mico.....	264		
■ SP212 Terra.....	263		
■ SP213 Urbus.....	266		
■ SP214 Forma.....	w		
■ SP215 Ferra.....	269		
■ SP216 Fumo.....	267		
■ SP217 Argento.....	265		
■ ST16 Grey Riven Slate.....	278		
■ ST17 Honed Oyster Slate.....	274		
■ ST19 Honed Charcoal Slate.....	279		
■ ST20 Honed Pebble Slate.....	276		

Product index by name

Wood

Argen WP414.....	240	Eastern Blackbutt VGW130T.....	213	Nordic Limed Oak KPI53-7.....	244	Washed Butternut RKP8108.....	113
Ashland LLP95.....	62	Ebony SCB-VGW89T.....	165	Nordic Limed Oak SCB-KPI53.....	168	Washed Character Oak KPI44-7.....	249
Auburn Oak AP02.....	202	Ebony VGW89T.....	225	North Coast Blackbutt LLP313.....	42	Washed Character Oak SCB-KPI44.....	173
Aurum WP315.....	237	Embered Blackbutt LLP314.....	54	Northern Spotted Gum SCB-VGW103T.....	159	Washed Grey Ash RKP8104.....	120
Australian Ghost Gum RKP8120.....	121	Evening Oak HC05.....	199	Northern Spotted Gum VGW103T.....	219	Waterbury LLP152.....	64
Australian Wormy Chestnut LLP334.....	53	French Grey Oak LLP308.....	49	Ochre Ironbark LLP326.....	55	Weathered American Pine LLP335.....	64
Autumn Oak RL03.....	190	French Oak VGW85T.....	217	Pale Limed Oak KP94-7.....	253	Weathered Heart Pine LLP304.....	44
Avena WP423.....	232	Frosted Acacia RKP8201.....	110	Pale Limed Oak SCB-KP94.....	177	Weathered Spotted Gum RKP8119.....	117
Baltic Mistral Oak RKP8112.....	126	Grano WP311.....	231	Palleo WP312.....	230	White Painted Oak KPI05-7.....	245
Baltic Washed Oak RKP8101.....	119	Greige Oak VGW110T.....	212	Pearl Oak LLP306.....	41	White Painted Oak SCB-KPI05.....	169
Blond Character Oak KPI43-7.....	248	Grey Brushed Oak RKP8216.....	112	Providence LLP108.....	71	Winter Oak RL04.....	191
Blond Character Oak SCB-KPI43.....	248	Grey Limed Oak KPI38-7.....	250	Pure Fabric Oak LLP329.....	45		
Blush Oak VGW107T.....	206	Grey Limed Oak SCB-KPI38.....	174	Raven Oak LLP302.....	58		
Birch SCB-VGW84T.....	150	Hamden LLP156.....	67	River Spotted Gum VGW131T.....	218		
Birch VGW84T.....	210	Hartford LLP112.....	76	Rose Washed Oak KP95-7.....	251		
Black Oak AP03.....	203	Hickory Nutmeg EW03.....	193	Rose Washed Oak SCB-KP95.....	175		
Bleached Grey Walnut WP329.....	236	Hickory Paprika EW01.....	192	Rubesco WP421.....	229		
Bleached Tasmanian Oak LLP311.....	40	Hickory Peppercorn EW02.....	194	Rubra WP316.....	239		
Blended Ironbark LLP328.....	48	Honey Ironbark LLP325.....	51	Shadow Fabric Oak LLP331.....	50		
Blond Oak AP01.....	201	Ignea WP313.....	238	Shadow Oak RKP8203.....	122		
Bridgeport LLP157.....	63	Lemon Spotted Gum LLP317.....	46	Shadow Studio Oak KPI50-7.....	259		
Brockton LLP153.....	65	Levanzo LLP150.....	73	Shadow Studio Oak SCB-KPI50.....	183		
Budelli LLP146.....	69	Light Barnwood RKP8207.....	124	Sicilia LLP142.....	70		
Cambridge LLP113.....	72	Light Distressed Oak VGW111T.....	208	Silver Barnwood RKP8208.....	125		
Canadian Urban Oak RKP8116.....	115	Light Worn Oak KPI04-7.....	256	Smoked Blackbutt RKP8106.....	129		
Carbo WP318.....	241	Light Worn Oak SCB-KPI04.....	180	Smoked Maple VGW128T.....	223		
Carbon Oak RKP8210.....	128	Lime Washed Oak KP99-7.....	252	Spring Oak RL01.....	188		
Champagne Oak LLP310.....	43	Lime Washed Oak SCB-KP99.....	176	Stained Acacia RKP8213.....	127		
Classic Oak SCB-VGW86T.....	160	Linosa LLP148.....	79	Stamford LLP109.....	74		
Classic Oak VGW86T.....	220	Magna WP413.....	235	Summer Oak RL02.....	189		
Classic Spotted Gum KPI49-7.....	255	Marron Elm VGW132T.....	224	Sundown Oak HC04.....	198		
Classic Spotted Gum SCB-KPI49.....	179	Mid Limed Oak KP96-7.....	257	Talpa WP319.....	234		
Coastal Blackbutt KPI57-7.....	246	Mid Limed Oak SCB-KP96.....	181	Tasmanian Oak LLP312.....	47		
Coastal Blackbutt SCB-KPI57.....	170	Midnight Oak HC06.....	200	Texas White Ash RKP8105.....	111		
Coastline Oak KPI47-7.....	247	Millstone Sycamore VGW133T.....	207	Traditional Character Oak KPI46-7.....	254		
Coastline Oak SCB-KPI47.....	171	Misty Grey Oak VGW112T.....	214	Traditional Character Oak SCB-KPI46.....	178		
Columba WP422.....	228	Morning Oak HC02.....	196	Tranquil Oak VGW135T.....	209		
Country Oak SCB-VGW81T.....	151	Mountain Spotted Gum LLP316.....	56	Twilight Oak LLP301.....	57		
Country Oak VGW81T.....	211	Natural Blackbutt RKP8121.....	118	Urban Spotted Gum KPI41-7.....	258		
Country Oak LLP92.....	66	Natural Ironbark LLP327.....	59	Urban Spotted Gum SCB-KPI41.....	182		
Danbury LLP154.....	77	Natural Maple VGW127T.....	216	Vintage Timber LLP105.....	75		
Dawn Oak HC01.....	195	Nimbus Oak RKP8205.....	123	Warm Ash RKP8103.....	114		
Distressed Oak VGW82T.....	221	Niveus WP411.....	233	Warm Spotted Gum RKP8118.....	116		
Dusk Oak HC03.....	197	Nocturne Oak VGW134T.....	222	Washed Blackbutt VGW129T.....	215		

Stone

Argento SP217.....	265	Vermont LLT217.....	91
Black Sands RKT3006-G.....	143	Vulcano LLT211.....	92
Capri LLT209.....	83		
Colorado LLT201.....	84		
Dakota LLT212.....	85		
Dove Grey Concrete ST21.....	187		
Dove Grey Concrete SCB-ST21.....	187		
Ferra SP215.....	269		
Forma SP214.....	268		
Fumo SP216.....	267		
Grey Riven Slate ST16.....	278		
Grey Riven Slate SCB-ST16.....	190		
Honed Charcoal Slate ST19.....	279		
Honed Charcoal Slate SCB-ST19.....	191		
Honed Oyster Slate ST17.....	274		
Honed Oyster Slate SCB-ST17.....	186		
Honed Pebble Slate ST20.....	276		
Honed Pebble Slate SCB-ST20.....	188		
Luna SP111.....	262		
Madison LLT203.....	93		
Maine LLT213.....	82		
Mezzo Grigio RKT2415.....	137		
Mezzo Perla RKT2414.....	133		
Mico SP211.....	264		
Natural Ecu RKT3015-G.....	136		
Nero SP115.....	271		
Nisida LLT210.....	90		
Ombra SP114.....	270		
Ontario LLT218.....	89		
Oxford Grey RKT2409.....	142		
Palazzo Marble RKT2413.....	132		
Pebble Grey RKT2410.....	139		
Pumice Stone RKT3016-G.....	134		
Quebec LLT219.....	87		
River Stone RKT3017-G.....	140		
Sandstorm RKT2411.....	138		
Smoke RKT2412.....	135		
Smoked Concrete ST22.....	189		
Smoked Concrete SCB-ST22.....	189		
Terra SP212.....	263		
Tino LLT208.....	86		
Urban Grey RKT3014-G.....	141		
Urbus SP213.....	266		
Utah LLT216.....	88		

Imagery and Design Reproduction

Photography and print cannot always produce a perfect representation of our products. This includes colour, pattern variation and installation elements used. For this reason we strongly recommend obtaining a product sample and where possible viewing a larger sample in-store. We also recommend visiting our website for information on installation, after care and product selection: www.karndean.com/advice

We love developing new ideas and improving on our existing designs which means that sometimes products are withdrawn at short notice. We hate to disappoint and will work with you to find an alternative design. Please contact customer services for more information.

Karndean Designflooring owns all their designs and are protected by copyright.

